

Traffic Signs Manual

CHAPTER 5

Road Markings
2018

Traffic Signs Manual

Chapter 5

Road Markings

Department for Transport

Department for Infrastructure (Northern Ireland)

Scottish Government

Welsh Government

Traffic Signs Manual

Contents of Chapters 1–8

CHAPTER 1 Introduction

CHAPTER 2 Informatory Signs*

CHAPTER 3 Regulatory Signs

CHAPTER 4 Warning Signs

CHAPTER 5 Road Markings

CHAPTER 6 Traffic Control

CHAPTER 7 The Design of Traffic Signs

CHAPTER 8 Traffic Safety Measures and Signs for Road Works and Temporary Situations

* To be published at a later date

Designers should consult the Department for Transport's website www.gov.uk for confirmation of current publication dates.

Published for The Department for Transport under licence from the Controller of Her Majesty's Stationery Office

© Crown copyright 2019

All rights reserved

Copyright in the typographical arrangement rests with the Crown.

This publication, excluding logos, may be reproduced free of charge in any format or medium for non-commercial research, private study or for internal circulation within an organisation. This is subject to it being reproduced accurately and not used in a misleading context. The copyright source of the material must be acknowledged and the title of the publication specified.

First published 2019

First edition Crown Copyright 1980

ISBN 978 0 11 553208 5

Printed In the United Kingdom for TSO (The Stationery Office)
J003473475 c2 01/19

1	INTRODUCTION	6
1.1	Overview	6
1.2	Legal	6
1.3	Definitions	7
1.4	References	7
1.5	Format	8
1.6	Use of road markings	8
1.7	Visibility	9
1.8	Colours	10
1.9	Reflectorisation	10
1.10	Working drawings	10
2	LONGITUDINAL LINES	11
2.1	General	11
2.2	Centre lines	11
2.3	Lane lines	14
2.4	Warning lines	15
2.5	Edge of carriageway lines	19
2.6	Raised profile edge lines	21
2.7	Hatched markings	23
2.8	Central traffic islands	26
2.9	Succession of central traffic islands	27
2.10	End of dual carriageway	28
2.11	Chevron markings	30
2.12	Layout of markings between junctions	31
3	DOUBLE WHITE LINES	34
3.1	General	34
3.2	Description	35
3.3	Road studs	36
3.4	Deflection arrows	36
3.5	Splayed markings on bends and crests	38
3.6	Inclined lines at refuges and traffic islands	38
3.7	Road junctions	39
3.8	Visibility distance	39
3.9	Design procedure for two-lane roads	39
3.10	Three-lane roads	41
3.11	Three-lane hills	41
3.12	Layout at crests	43
3.13	Layout at sag curves	44
3.14	Four-lane roads	44
3.15	Level crossings	44

4	ROAD STUDS	47
4.1	General	47
4.2	Type approval	48
4.3	Types of road stud	48
4.4	Colour of road studs	48
4.5	Stud spacing	49
5	MAJOR / MINOR JUNCTIONS	50
5.1	General	50
5.2	Simple junctions	50
5.3	Ghost island junctions	51
5.4	Dual carriageway junctions	57
5.5	Single lane dualling	59
6	ROUNABOUTS	61
6.1	General	61
6.2	Conventional roundabouts	61
6.3	Mini-roundabouts	63
6.4	Double roundabouts	65
6.5	Signalised roundabouts	66
6.6	Lane markings in the circulating area	66
6.7	Lane destination markings and arrows	68
6.8	Segregated left-turn lanes	69
6.9	Yellow box markings	70
6.10	Transverse yellow bar markings	71
6.11	Special cases	73
7	GRADE SEPARATED JUNCTIONS	75
7.1	Design	75
7.2	Taper merges and diverges	75
7.3	Lane-gains	78
7.4	Lane-drops	81
7.5	Ghost island diverges	83
7.6	Auxiliary lanes	85
7.7	Actively managed hard shoulders	86
8	YELLOW BOX JUNCTION MARKINGS	89
8.1	Legal aspects	89
8.2	Design and layout	89
8.3	Suitability	90
8.4	Setting out	93
8.5	Railway level crossings	95
9	ARROWS AND LANE DESTINATIONS	97
9.1	Lane arrows	97
9.2	Lane destinations	98
9.3	Compulsory turns	99
9.4	Guidance arrows	99
9.5	Deflection arrows	100
9.6	Bifurcation arrows	101

10	TRAFFIC CALMING	102
10.1	Introduction	102
10.2	Markings on road humps	102
10.3	Markings on speed cushions	103
10.4	Markings on thermoplastic humps	104
10.5	Build-outs	104
10.6	Chicanes and pinch points	105
10.7	Gateways	105
11	WORDED AND DIAGRAMMATIC MARKINGS	106
11.1	General	106
11.2	Slow marking	106
11.3	High vehicle markings at arch bridges	106
11.4	Keep clear markings	107
11.5	Look left / look right	110
11.6	Vehicle separation markings	110
11.7	Formation of words	112
12	MATERIALS AND MAINTENANCE	116
12.1	General	116
12.2	Road marking materials	116
12.3	European and British standards	116
12.4	Reflectorisation	117
12.5	Statutory colours	119
12.6	Application of markings	119
12.7	Maintenance	119
12.8	Drainage	120
Appendix A Northern Ireland variations		121
LIST OF FIGURES		122
LIST OF TABLES		125
INDEX		126

1.1 Overview

1.1.1. The Traffic Signs Manual (the Manual) offers advice to traffic authorities and their contractors, designers and managing agents in the United Kingdom, on the correct use of traffic signs and road markings on the highway network. Mandatory requirements are set out in the Traffic Signs Regulations and General Directions 2016 (as amended) (TSRGD). In Northern Ireland the relevant legislation is the Traffic Signs Regulations (Northern Ireland) 1997 (as amended). Whilst the Manual can assist with complying with the mandatory requirements, it cannot provide a definitive legal interpretation, nor can it override them. This remains the prerogative of the courts or parking adjudicators in relation to the appearance and use of specific traffic signs, road markings etc. at specific locations.

1.1.2. The advice is given to assist authorities in the discharge of their duties under section 122 of the Road Traffic Regulation Act 1984 and Part 2 of the Traffic Management Act 2004 in England and under Part 1 of the Roads (Scotland) Act 1984. Subject to compliance with the Directions, which are mandatory (see [1.4.2](#) and [1.4.3](#)), it is for traffic authorities to determine what signing is necessary to meet those duties.

1.1.3. The Manual applies to the United Kingdom. References to “the national authority” should therefore be interpreted as referring to the Secretary of State for Transport, the Department for Infrastructure (Northern Ireland), the Scottish Government or the Welsh Government as appropriate. Any reference to the “Department” is a reference to the Department for Transport or the appropriate national authority for Northern Ireland, Scotland or Wales as described above.

1.1.4. This chapter of the Manual describes the design and use of road markings (including road studs), i.e. markings on the surface of the road for the control, warning, guidance or information of road users. It should not be used as a design document for junction layouts etc. Where markings are used to supplement upright signs or placed in connection with traffic signals and pedestrian crossings, guidance on these can be found in the following chapters:

- | | |
|---|-----------|
| a) Stop and Give Way markings: | Chapter 3 |
| b) Signal controlled junctions: | Chapter 6 |
| c) Pedestrian crossings: | Chapter 6 |
| d) Cycle markings: | Chapter 3 |
| e) Bus markings: | Chapter 3 |
| f) Tram markings: | Chapter 3 |
| g) Control of on street parking: | Chapter 3 |
| h) Markings associated with regulatory signs: | Chapter 3 |

1.2 Legal

1.2.1. All road markings and road studs placed on a highway or on a road to which the public has access (right of passage in Scotland), as defined in section 142 of the Road Traffic Regulation Act 1984 and amended by the New Roads and Street Works Act 1991, must be either prescribed by Regulations or authorised by the Secretary of State for Transport (for installations in England), the Department for Infrastructure (Northern Ireland), the Scottish Government or the Welsh Government as appropriate.

1.2.2. Care should be taken to ensure that markings and studs are used only as prescribed in the Regulations, and in accordance with any relevant directions, and that no non-prescribed marking or stud is used unless it has been formally authorised in writing. Failure to do so may leave an authority open to litigation, or make a Traffic Regulation Order unenforceable.

1.2.3. Certain road markings may be used only if supported by a Traffic Regulation Order or other statutory provision, whilst others, e.g. yellow box markings (diagram 1043; S9-6-25), have legal implications in that not complying with them could constitute a traffic offence under section 36 of the Road Traffic Act 1988.

1.2.4. The Regulations require the use of white road studs in conjunction with double white lines (diagrams 1013.1 and 1013.5; S9-6-23 & S9-6-24 respectively). Guidance on the more general use of road studs is given in section 4.

1.2.5. Clarification of current policy on the use of edge of carriageway markings and associated road studs in Northern Ireland should be sought from the Department for Infrastructure's headquarters.

1.2.6. There could be circumstances where it might be appropriate to use prescribed markings in a manner that is not strictly in accordance with the General Directions or the Schedule-specific Directions. In such cases, a special direction (not an authorisation), given in writing, should be sought from the national authority. Markings and road studs may be placed only by, or with the permission of, the traffic authority.

1.2.7. Occasionally a sign that is not prescribed by the Regulations may be authorised by the national authority for placing on a public highway.

1.3 Definitions

1.3.1. In the Manual, the word "must" is used to indicate a legal requirement of the Traffic Signs Regulations and General Directions (or other legislation) that must be complied with. The word "should" indicates a course of action that is recommended and represents good practice. The word "may" generally indicates a permissible action, or an option that requires consideration depending on the circumstances.

1.3.2. Section 64 of the Road Traffic Regulation Act 1984 defines a traffic sign as "any object or device (whether fixed or portable) for conveying to traffic on roads or any specified class of traffic, warnings, information, requirements, restrictions or prohibitions of any description ... and any line or mark on the road for so conveying such warnings, information, requirements, restrictions or prohibitions" and stipulates that these signs be "specified by regulations made by the national authority, or authorised by the national authority". The types of signs and carriageway markings and their appropriate use are prescribed in TSRGD.

1.3.3. "Signing" includes not only traffic signs mounted on supports (and other structures such as gantries, bridges, railings, etc.) but also carriageway markings, beacons, studs, bollards, traffic signals, matrix signals and other devices prescribed in TSRGD.

1.4 References

1.4.1. Any reference to the "Regulations" or the "Directions" is a reference to the Traffic Signs Regulations and General Directions 2016, applicable to England, Scotland and Wales. Reference to a diagram number or to a Schedule is a reference to a diagram or Schedule in those Regulations.

1.4.2. In Northern Ireland, the relevant legislation is the Traffic Signs Regulations (Northern Ireland) 1997 as amended (see [Appendix A](#)). Diagram numbering occasionally differs in these Regulations and references to Schedules do not apply to Northern Ireland. The design of road markings, meanings and permitted variants are generally similar but can vary; where the Northern Ireland Regulations apply, the designer is advised to read them in conjunction with the Manual.

1.4.3. Not all road markings referred to in the text are included in the Northern Ireland Regulations. References to directions are not applicable in Northern Ireland; where these are referred to, advice should be sought from the Department for Infrastructure's headquarters.

1.5 Format

1.5.1. Any reference to a "Chapter" is a reference to a Chapter of the Traffic Signs Manual, and any reference to a "section", unless otherwise stated, is a reference to a section within a chapter of the Manual. Where more detailed background information might be helpful, reference is made to Standards and Advice Notes in the Design Manual for Roads and Bridges (DMRB), published by TSO and available on the Department's website at:

www.standardsforhighways.co.uk/dmrb/

1.5.2. References to Schedules, Parts, items and paragraphs within TSRGD are shown in an abbreviated format. In this system, "Schedule" is shortened to "S" and "Part" is indicated by the second number without a prefix. The final element, variously "item" or "paragraph" is also denoted by a number without a prefix. This is illustrated in the following examples:

"Schedule 9, Part 6, item 25" becomes "S9-6-25"

"Schedule 11, Part 6, paragraph 3" becomes "S11-6-3"

"Schedule 12, Part 2" becomes "S12-2"

1.5.3. The numbering system contained in the Manual utilises three levels comprising sections, sub-headings and numbered paragraphs. Internal references are in **bold blue**.

1.6 Use of road markings

1.6.1. Road markings serve a very important function in conveying to road users information and requirements which might not be possible using upright signs. They have the advantage that they can often be seen when an upright sign is obscured and can also provide a continuing message.

1.6.2. Road markings have their limitations. They can be completely obliterated by snow. Their conspicuity is impaired when wet or dirty, and their effective life is reduced if they are subjected to heavy trafficking. Designers should give careful consideration to performance, wear, maintenance and whole life costs when selecting the appropriate material.

1.6.3. Nevertheless, road markings make a vital contribution to safety, e.g. by clearly defining the path to be followed through hazards, by separating conflicting movements and by delineating the road edge on unlit roads at night. They can also help to improve junction capacity, and make best use of available road space. In particular, widespread use of lane markings is desirable as they encourage lane discipline and improve the safety and efficiency of traffic flow. Longitudinal lines should be designed to ensure a flowing alignment, avoiding sudden changes of direction or sharp tapers of inadequate length. Road marking layout should always be considered in detail at the design stage of any scheme.

1.6.4. Because of the angle at which they are viewed, road markings appear heavily foreshortened. This effect is countered in the case of worded markings by elongating the legend (see [11.7.3](#) to [11.7.5](#)). Two sizes are prescribed; the larger marking is legible at a greater distance and is used where traffic speeds are higher. Similarly, longitudinal lines need to be wider and longer where speeds are high, in order to maintain adequate conspicuity.

1.6.5. In order to achieve safe and efficient operation of a highway network, it is essential that all signing provided is necessary, clear and unambiguous, and gives its message to road users at the appropriate time. The message must be quickly and easily understood at the point it is needed; neither too soon that the information might be forgotten, nor too late for the safe performance of any necessary manoeuvre.

1.7 Visibility

1.7.1. For road markings to be effective, they need to be clearly visible both by day and by night. Markings have two principal functions. The first is symbolic; the driver needs to have learned, for example, that a hollow triangular marking with its apex downwards means 'give way'. The second is guidance; centre lines, edge lines and lane lines help drivers to maintain their lateral position on the road. Some markings, e.g. hazard lines and double white line systems have both symbolic and guidance functions.

1.7.2. The guidance function is less critical (although still important) in daylight or on lit roads because there are many visual cues available to enable the driver to judge course and position. On unlit roads at night, conditions are very different; the visual stimuli in the distance and to the sides of the road are largely absent. Road markings then become the most important aid in enabling the driver to follow the road.

1.7.3. Collaborative European research has shown that drivers need to be able to detect guidance markings at a distance equivalent to a minimum of two seconds of travel time. If the visibility is less than this, drivers tend to adjust too late when the road changes direction. They run too close to the centre line on left hand bends, or too close to the road edge on right hand bends. The higher the prevailing traffic speed, the greater the visibility distance required to maintain this two-second "preview time". If it is not provided, drivers tend to miss the curve, or proceed in a series of staggers.

1.7.4. A variety of factors influence the visibility distance of a road marking. It is increased when a line is wider, has a higher mark-to-gap ratio or has a higher coefficient of retroreflected luminance (in the day time, higher contrast with the road surface). Visibility distance is adversely affected by glare from oncoming vehicles, dirty headlamps or windscreen and especially by rain; the glass beads which produce the night time luminance are drowned by excess water, greatly reducing the brightness of the line. Older drivers also see a marking less well than younger drivers; someone seventy years old might suffer a reduction in visibility distance of more than 20% compared with drivers still in their twenties.

1.7.5. The marking regime prescribed in the UK generally gives adequate levels of guidance in good conditions, i.e. where the road is dry, the driver is young, the vehicle has clean, powerful headlamps and there is no glare from oncoming vehicles. On roads with high traffic speeds, wider lines should normally be adopted where alternatives are prescribed. It is important that guidance markings are well maintained. Severe wear reduces both effective width and retroreflective performance, and hence the visibility distance. Further guidance on the maintenance of road markings can be found in [12.7](#).

1.8 Colours

1.8.1. Road markings are prescribed in the colours white, yellow and red. Further details can be found in [12.5](#). Red markings are used to indicate red routes and entrances to congestion charging zones (see Chapter 3).

1.8.2. The colours and location of stud reflectors with respect to the running lanes are detailed in [4.4](#).

1.9 Reflectorisation

1.9.1. Most road markings that have a guidance function are required to be illuminated by retroreflecting material. A full list appears in [Table 12-1](#). Retroreflectivity is achieved through the addition of glass beads applied directly to the surface of the road marking during the application process and, in the case of thermoplastic, through the presence of glass beads incorporated within the material itself. This makes the marking much brighter at night than non-reflectorised materials. The British Standard for road markings (BS EN 1436) specifies several different classes for night-time brightness. Brighter markings are visible at greater distances, and may provide an acceptable level of performance for a longer time before renewal becomes necessary (see [12.3](#) and [12.4](#)).

1.9.2. Markings which maintain night-time performance even when wet may also be specified. This is usually achieved by the use of larger glass beads, but the wet performance of certain road markings may also be enhanced by the use of raised profiles (see [2.6](#) and [12.4.3](#)).

1.10 Working drawings

1.10.1. Dimensions on the figures are in millimetres unless stated otherwise. Many markings are fully dimensioned in the Regulations. Detailed working drawings of the more complex ones are available at:

www.gov.uk/government/collections/trafficsignsignalsandroadmarkings

1.10.2. Workings drawings for Welsh and English bilingual markings are available at

www.traffic-wales.com/traffic_signs.aspx

2.1 General

2.1.1. The Regulations prescribe (except in Northern Ireland, see [2.1.2](#)) two separate module sizes for centre lines (diagrams 1008 and 1008.1 S11-4-6 & 7, see [2.2](#)), lane lines (diagrams 1005 and 1005.1, S11-4-4 & 5, see [2.3](#)) and warning lines (diagram 1004 and 1004.1, S11-4-2 & 3, see [2.4](#)). Guidance on the appropriate module size is given in each of the relevant sub-sections.

2.1.2. In Northern Ireland, the smaller module (1008, 1005 and 1004) is used where the speed limit is 40 mph or less and the larger module (1008.1, 1005.1 and 1004.1) where the speed limit is greater than 40 mph.

2.2 Centre lines

2.2.1. Centre line markings, separating opposing flows of traffic on single carriageway roads, are illustrated in [Figure 2-1](#). The dimensions and recommended applications are shown in [Table 2-1](#). Diagram 1008 should always be used where the permanent speed limit is 40 mph or less. Where the speed limit is more than 40 mph, diagram 1008.1 should generally be used. However, where the 85th percentile speed is below 40 mph over most of the length of road, then diagram 1008 might be more appropriate (see [2.1](#)).

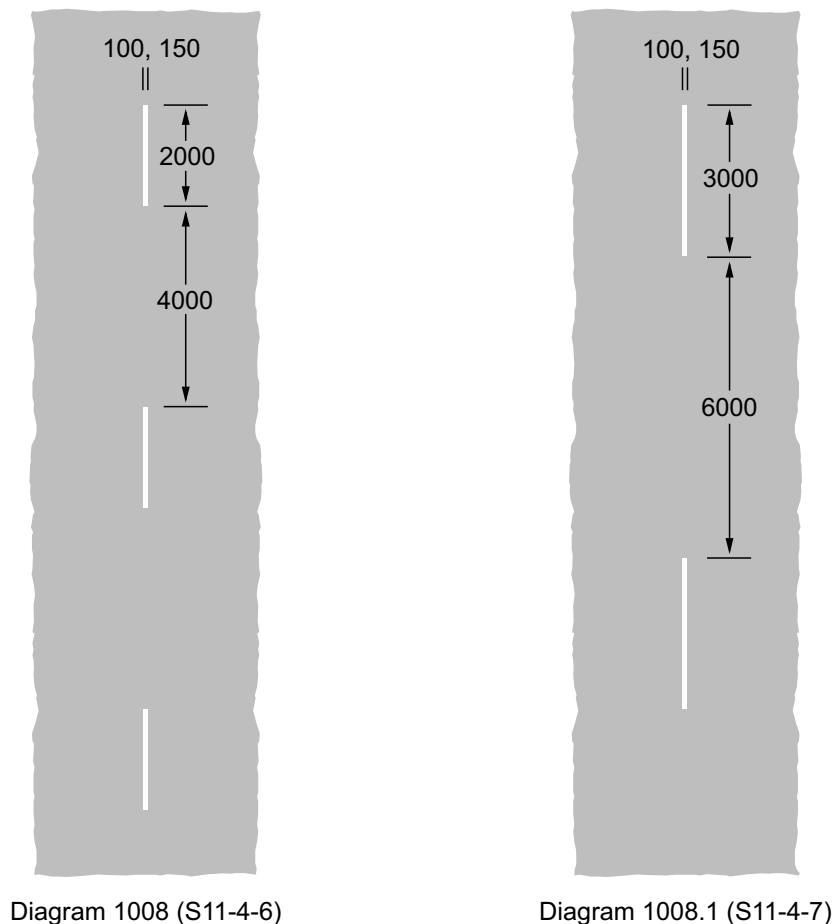

Figure 2-1 Centre lines

2.2.2. The marking to diagram 1008 or 1008.1 should be used only on single carriageway roads. Where the road comprises one lane in each direction, the 100 mm wide marking will normally be sufficient. On four-lane roads, three-lane roads marked as two in one direction and

one in the other, or two-lane roads that are 10 m wide, the 150 mm marking should be used. Lane lines, where provided, should be 100 mm wide (see 2.3). The centre line should never be narrower than the lane line (see 2.3.4). It may be replaced by the warning line (see 2.4) where appropriate. Where there are two or more lanes in each direction, consideration might be given to double white lines (see section 3). Double white lines are used also for three-lane rural roads as detailed in TD 70 'Design of Wide Single 2+1 Roads'.

Table 2-1 Centre lines on single carriageway roads

Diagram no. (TSRGD ref)	Speed limit (mph)	Width (mm)	Spacing of studs (if used) (m)	Description
1008 (S11-4-6)	40 or less	100	12	Two-lane roads, not less than 5.5 m in width
1008	40 or less	150	6	Two-lane roads 10 m or more in width
				Three-lanes marked as two in one direction and one in the other (see 2.2.2)
				Four-lanes or more (see 2.2.2)
1008 ¹	Over 40	100	12	Two-lane roads, not less than 5.5 m in width where the 85th percentile speed is generally below 40 mph (see 2.1 and 2.2.1)
1008.1 (S11-4-7)	Over 40	100	18	Two-lane roads, not less than 5.5 m in width
1008.1 ²	Over 40	150	9	Two-lane roads 10 m or more in width
				Three-lanes marked as two in one direction and one in the other (see 2.2.2)
				Four-lanes or more (see 2.2.2)

NOTE 1: Where the marking to diagram 1008 is used on a road with a speed limit greater than 40 mph it should be used consistently and not interchanged with diagram 1008.1 at frequent intervals.

NOTE 2: Volume and speed of HGV traffic needs to be considered when determining the width of diagram 1008.1 to be used.

2.2.3. Where forward visibility is restricted (see 2.4.5) or on the approach to some other hazard (e.g. a roundabout or other junction), the centre line marking should be replaced with a warning line to diagram 1004 or 1004.1 (see Figure 2-4). These are the inverse of the mark / gap dimensions for the centre line and should normally be chosen to maintain the same module length (see Table 2-3 for the minimum number of marks). However, there might be some situations where it is appropriate to use a warning line that has a different module length to that of the centre line marking to diagram 1008 or 1008.1. This could occur, for example, where the speed limit changes from the national limit of 60 mph to 40 or 30 mph. In this case the marking to diagram 1004.1 would normally be used on the approach to the lower limit, with diagram 1004 being used beyond the speed limit terminal signs.

2.2.4. It is recommended that the marking to diagram 1004.1 is used within the lower limit where the number of modules to diagram 1004 would be seven or less (see Figure 2-2). Likewise, if the warning line to diagram 1004 is used for a longer distance within the lower limit, it might be appropriate to continue this marking within the higher speed limit in situations where a change to diagram 1004.1 would result in less than seven modules of that diagram (see Figure 2-2 and 2.2.3).

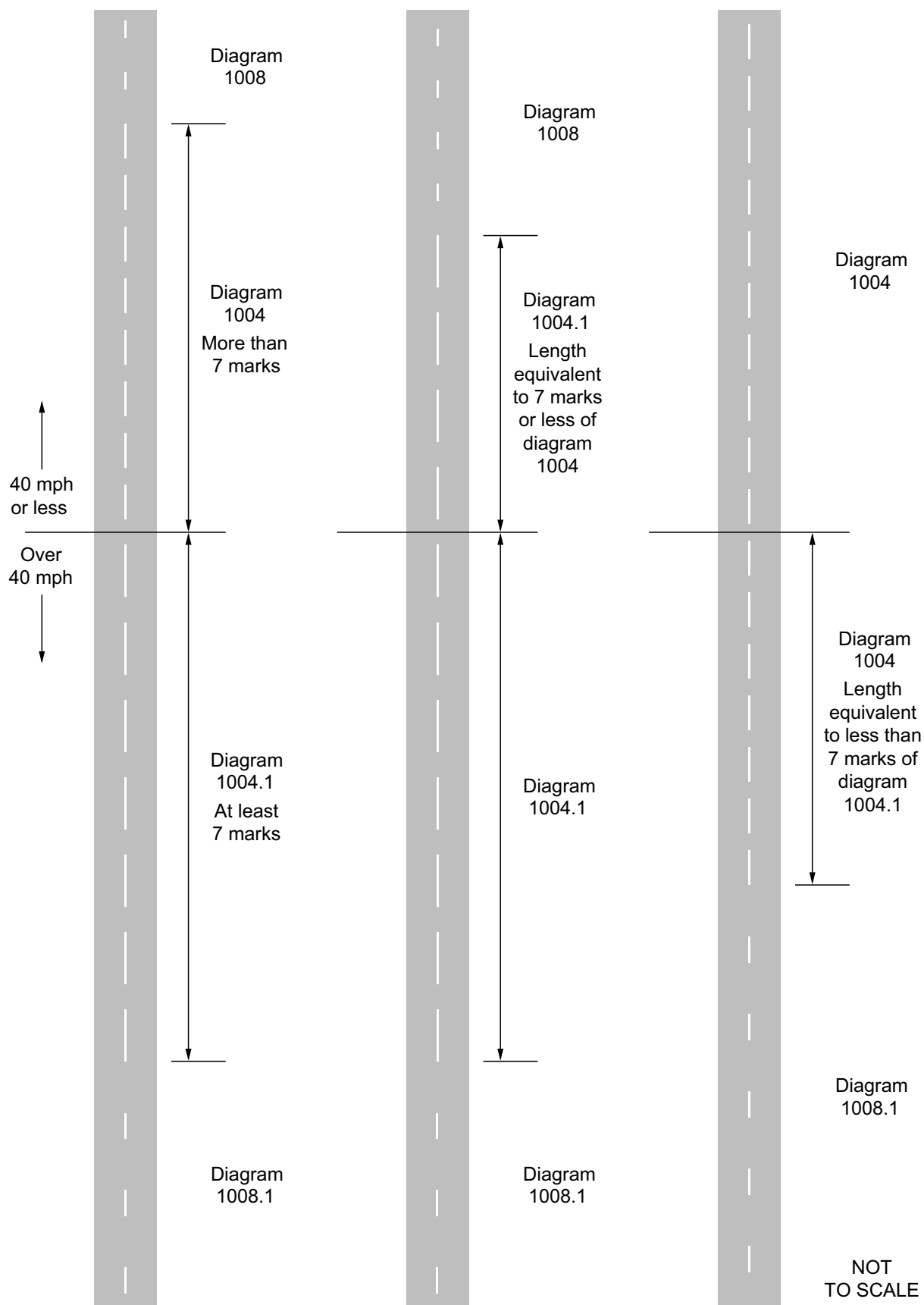

Figure 2-2 Use of warning lines where there is a change of speed limit

2.2.5. On two- or four-lane roads the centre line marking should normally be laid in the geometric centre. It can however be laid off-centre to allow parking along one side. Where it is necessary to change the position of lines in relation to the centre of the road, the deflection should be smooth and made at the inclinations specified in [Table 2-7](#).

2.2.6. On rural roads below 5.5 m in width, over-running of the carriageway edge can occur if centre line markings are provided, causing maintenance problems. Drivers might also expect a road marked with a centre line to be wide enough for opposing lanes of traffic to pass. In these circumstances the centre line should be omitted, but it is recommended that edge of carriageway markings would be helpful.

2.3 Lane lines

2.3.1. Lane lines (see [Figure 2-3](#)) ensure that available carriageway space is used to its maximum capacity. In helping drivers to maintain a consistent lateral position, they also offer safety benefits and should be used wherever practicable.

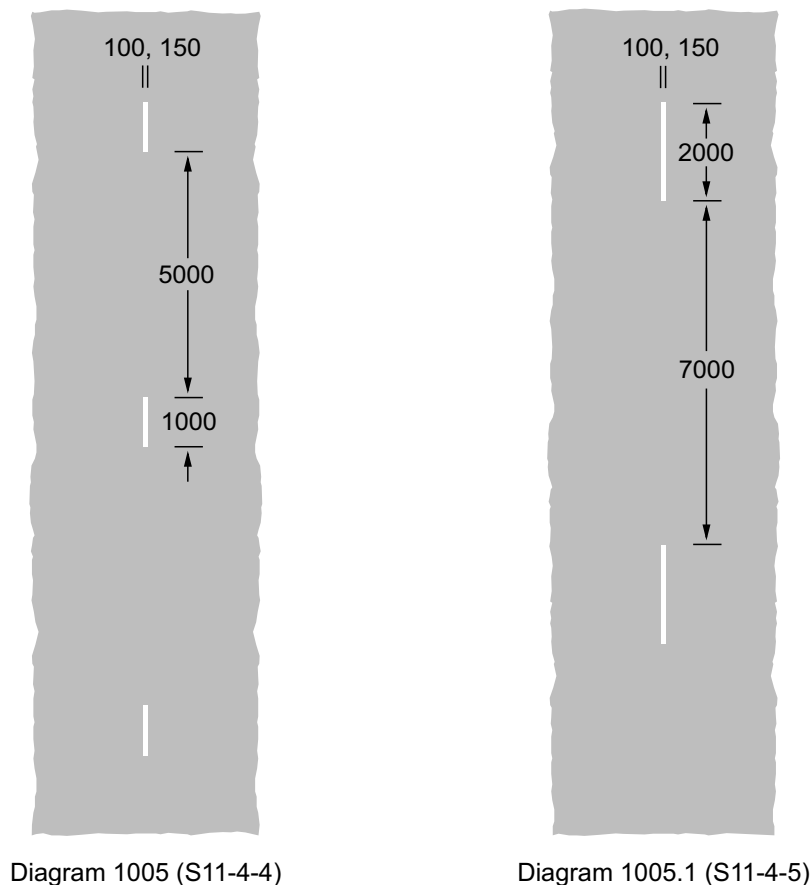

Figure 2-3 Lane lines

2.3.2. The marking is intended for dividing the carriageway into lanes where traffic on either side of the line travels in the same direction, and not for separating opposing flows of traffic. Details are set out in [Table 2-2](#).

2.3.3. Lane lines on the approach to Give Way and Stop markings, including roundabouts and traffic signals, should change to warning lines in accordance with [Table 2-3](#) and [2.4.9](#) to [2.4.13](#).

2.3.4. On single carriageway two-way roads with two or more lanes for traffic travelling in the same direction, the centre line should normally be of a greater width than the lane lines. This is particularly important when the warning module is used for both, making it more difficult to determine which line divides the opposing traffic streams.

2.3.5. On 70 mph dual carriageway all-purpose roads and on motorways, the wider (150 mm) marking should be used as this increases its visibility distance. It is also likely to be of benefit on concrete roads, or roads with a buff coloured surface dressing, even with a lower speed limit, helping to compensate for the reduced contrast.

Table 2-2 Lane lines

Diagram no. (TSRGD ref)	Speed limit (mph)	Width (mm)	Spacing of studs (if used) (m)
1005 (S11-4-4)	40 or less	100 (150)	12
1005.1 (S11-4-5)	Over 40	100 (150)	18

NOTE: Volume and speed of HGV traffic needs to be considered when determining the width of diagram 1005.1 to be used.

2.4 Warning lines

2.4.1. Warning lines are detailed in [Figure 2-4](#) and [Table 2-3](#). They are used:

- a) as centre lines at bends and crests, and on multi-lane roads (see [2.4.5](#) to [2.4.7](#)),
- b) as centre lines where it is necessary to highlight the presence of a road junction, central refuge or other hazard (see [2.4.8](#) to [2.4.12](#) and [2.8](#)),
- c) as lane and centre lines approaching or through a junction (see [2.4.13](#), sections [7](#), [8](#), and [10](#) and Chapter 6),
- d) at lane-gains (see [Figure 7-4](#))
- e) at a taper merge followed by a lane-gain (see [Figure 7-5](#))
- f) at a lane-gain followed by a taper merge (see [Figure 7-6](#))
- g) at taper merge auxiliary lanes (see [Figure 7-10](#))
- h) to mark the boundary of advisory cycle lanes (see Chapter 3), and
- i) over road humps (see section [10](#)).

2.4.2. Warning lines are always single; they must never be used as part of a double line installation, and must not be formed of raised rib markings (see [2.6](#)).

2.4.3. Two patterns of warning line are prescribed, each having alternative widths of 100 or 150 mm. The wider line is visible at a greater distance, and should be used where this might be beneficial, e.g. at particularly hazardous sites (see also [2.3.4](#)). The two standard modules are 6 metres and 9 metres in length (the combination of one mark and one gap) generally depending on the speed limit (see [2.1](#), [2.2.3](#) and [2.4.9](#)). [Table 2-3](#) sets out appropriate arrangements for various road layouts and speed limits.

2.4.4. Only hazards that are unusual for the road environment or not immediately obvious should be marked by warning lines. Overuse of the marking should be avoided. Its use where it is not justified will devalue its effect. Particular care should be taken in urban areas where there might be a temptation to use it extensively.

2.4.5. Warning lines are used in place of centre lines where forward visibility is less than the warning line visibility distance (W) indicated in [Table 2-4](#). This is based on the visibility necessary for safe overtaking on a two-way carriageway (see [3.8](#) for the definition of visibility distance) and is related to actual traffic speed, not the speed limit. Where the visibility distance is less than the desirable minimum (V), a double white line system should be considered (see section [3](#)). It should be noted that the values for V and W are not interpolated within a particular speed range, e.g. for an 85th percentile speed of 45 mph, V and W are 120 m and 195 m respectively.

2.4.6. Where warning lines are used to separate opposing flows of traffic on single carriageway roads, they should normally be laid in the geometric centre of the carriageway (see also [2.2.5](#)).

2.4.7. On four-lane roads, the 150 mm wide warning line should be used to separate opposing traffic, although consideration could be given to the use of double white lines (see section 3). On three-lane roads, other than those described in TD 70 (see 3.10.1), marked with two lanes in one direction and one in the other, the 150 mm wide line should be used to divide the flow of traffic, together with 100 mm wide lane lines (see also 2.2.2). The lane line should never be wider than the warning line in order to avoid driver confusion.

2.4.8. Warning lines can be used to highlight the presence of a road junction (see section 5 for further guidance) and to mark the approach to central refuges (see 2.8 and 2.9) or other hazards (see 2.4.13), except where these are within a double line section.

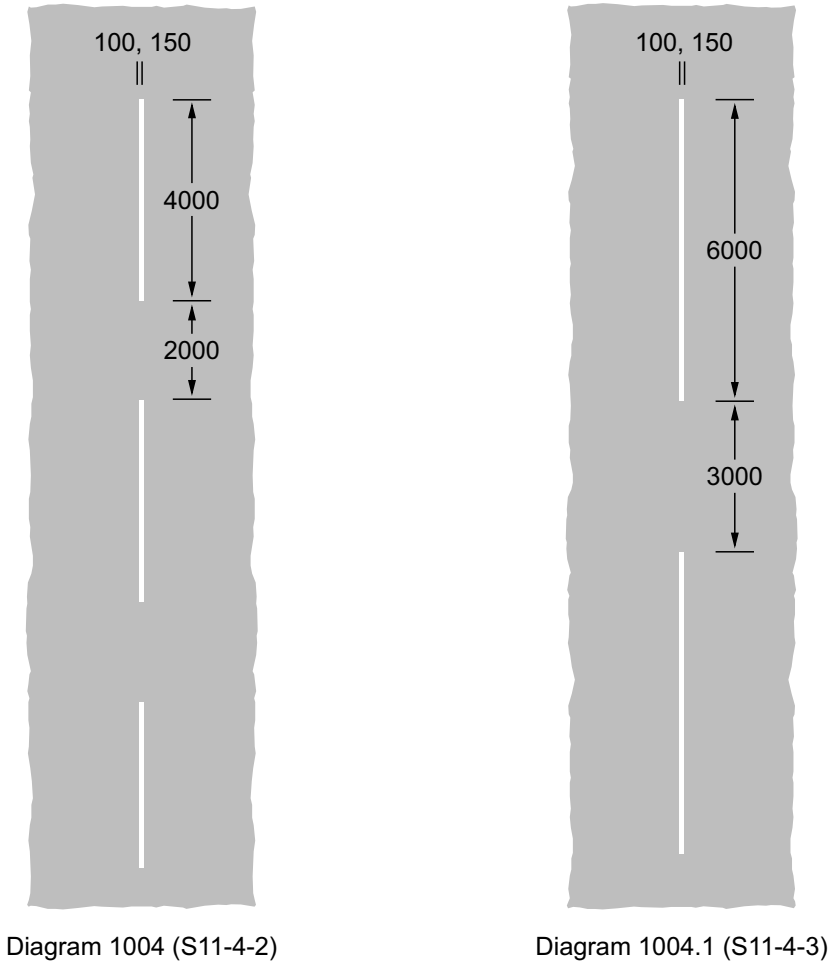

Figure 2-4 Warning lines

2.4.9. On straight sections of road, warning lines on the priority route at a junction would normally be appropriate when the average traffic volume from the side road exceeds about 100 vehicles per hour. However, warning lines will be justified at lower traffic volumes where visibility of the junction is impaired.

2.4.10. If the minor road is a one-way street, a warning line on the major road will normally be needed only if the direction of flow is towards the major road. The principal purpose of the marking is to warn drivers of the risk of unseen vehicles emerging.

2.4.11. The minor road should generally be marked with at least the minimum number of marks shown in Table 2-3. Where the minor road is over 5.5 m wide at the Give Way marking, but narrows quickly, as many marks as possible should be provided in the wider area. Where the speed limit on the minor road is 40 mph or less, diagram 1004 should be used. This marking might also be preferable to diagram 1004.1 where the speed limit is greater than 40 mph, particularly where traffic speed on the approach to the junction is below 40 mph or where speed

limit terminal signs are placed within the minor road to indicate a speed limit on the major road of 40 mph or less. On narrow two-way minor roads where the Give Way or Stop marking is extended over the whole width (see Chapter 3), a warning line is not provided.

2.4.12. The number of marks recommended in [Table 2-3](#) is the minimum that should normally be provided, although this is not always possible on minor roads (see [2.4.9](#)). The number of marks should be increased wherever justified by road or traffic conditions and could be extended to start at the location of the accompanying warning sign indicating a bend, road junction or other hazard ahead. [Figure 2-5](#) indicates a possible combination of signs and markings at a road junction. This arrangement is not intended to be used at all junctions, but may be appropriate at difficult sites where, for example, overtaking might cause a problem on the approach to a junction.

2.4.13. On dual carriageway roads, or single carriageway roads with two or more lanes in one direction, warning lines should be used in place of lane lines on the immediate approach to signal controlled junctions or roundabouts. Where additional lanes are introduced on the immediate approach to a roundabout it might not be possible to provide the minimum number of marks. In such cases as many marks as possible should be used without reducing any lane width below 2 m at the start of the taper (see [6.7.2](#)). As with minor roads at priority junctions, the marking to diagram 1004 might be appropriate at some locations where the speed limit is greater than 40 mph (see [2.4.9](#)). The detailed arrangements for marking roundabouts and signal controlled junctions are described in section [6](#) and Chapter 6 respectively.

2.4.14. Where there are two features that would justify warning lines (e.g. two junctions, or a junction followed by a bend), then a short length of standard centre line between two warning lines can help to highlight the separate hazards, even if this results in fewer than the minimum number of marks being provided for the second hazard.

Table 2-3 Warning lines

Diagram no. (TSRGD ref)	Speed limit (mph)	Width (mm)	Spacing of studs (if used) (m)	Minimum number of marks on each approach			Purpose
				Speed limit (mph)			
				30	40	Over 40	
1004 (S11-4-2)	40 Or less	100	6	5	7	-	Central warning line on two-lane roads less than 10 m wide ¹
1004.1 (S11-4-3)	Over 40	100	9	-	-	7	
1004	40 Or less	150	6	5	7	-	Central warning line on two-lane roads 10 m or more wide
1004.1	Over 40	150	9	-	-	7	
1004	40 Or less	150	6	7	10	-	Central warning line on four or six-lane single carriageway roads
1004.1	Over 40	150	9	-	-	10	
1004	40 Or less	100	6	5	7	-	Lane line on all roads on approach to roundabouts or signal controlled junctions, and the minor road approaching a priority junction ²
1004.1	50	100	9	-	-	7	
	60	100	9	-	-	7	
	70	150	9	-	-	7	

NOTE 1: The marking to diagram 1004 using a minimum of 7 marks might be appropriate on roads where the speed limit is over 40 mph, but traffic speeds are generally below 40 mph (see 2.1).

NOTE 2: The marking to diagram 1004 might be appropriate on the minor road approach to a priority junction where the speed limit is over 40 mph (see 2.4.9).

NOTE 3: See 2.2.3 in respect of warning lines where the speed limit along a length of road changes from one that is above 40 mph to one that is 40 mph or less.

NOTE 4: These markings may also be used to delineate an advisory cycle lane (see Chapter 3).

NOTE 5: Volume and speed of HGV traffic should be considered when determining the width of diagram 1004.1 to be used.

Table 2-4 Visibility distance

85th percentile speed of private cars (mph)	Desirable minimum visibility distance V (m)	Warning line visibility distance W (m)
Up to 30	75	115
31 to 40	95	160
41 to 50	120	195
51 to 60	150	240
Over 60	175	275

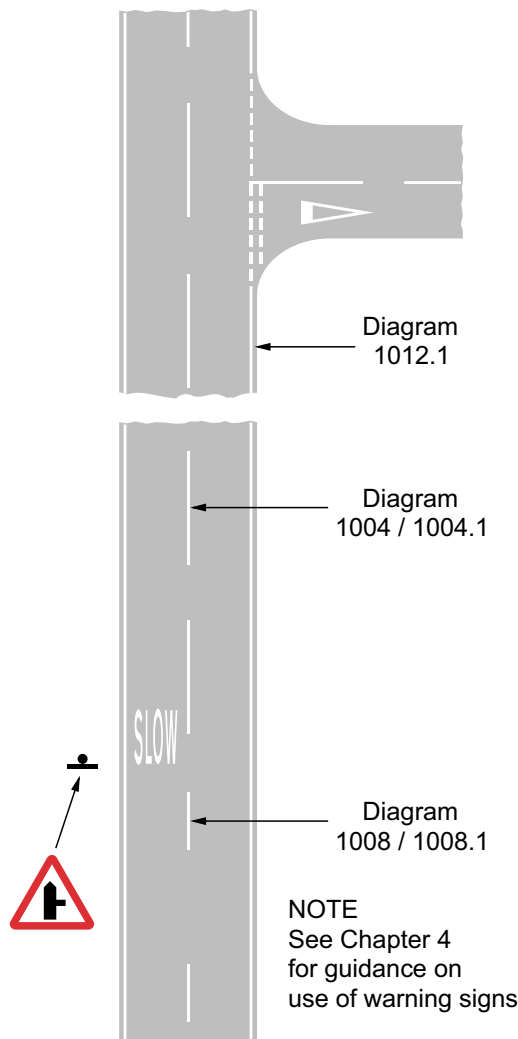

Figure 2-5 Typical road junction

2.5 Edge of carriageway lines

2.5.1. The following types are prescribed:

- diagram 1009A (see [Table 2-5](#), [Figure 2-6](#), and [2.5.3](#)),
- diagram 1009B (S11-4-9) (for use at a junction of a cycle track and another road; see Chapter 3),
- diagram 1010 (see [Table 2-5](#), [Figure 2-6](#), [2.5.4](#) and [2.5.5](#)),
- diagram 1012.1 (see [Table 2-5](#), [Figure 2-6](#), [2.5.6](#) to [2.5.13](#), [2.6.3](#), [2.6.7](#) and, when used at level crossings, Chapter 6), and
- diagrams 1012.2 and 1012.3 (see [Table 2-5](#), [Figure 2-7](#) and [2.6](#)).

2.5.2. Under no circumstances should edge of carriageway markings be used as a substitute for the Give Way line at a priority junctions (see Chapter 3).

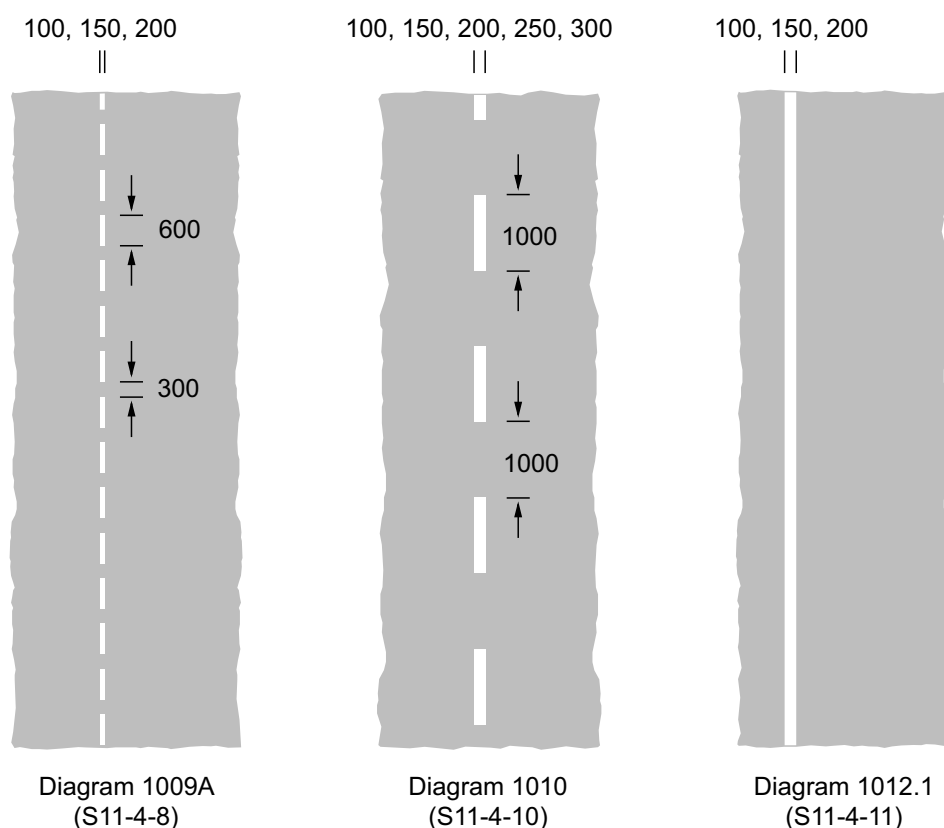

Figure 2-6 Edge of carriageway lines

2.5.3. Chapter 3 deals with diagram 1009A where it is used in conjunction with Give Way and Stop line markings at priority junctions, and also where it is used to indicate the start of a cycle lane. Elsewhere, the marking may be used as an alternative to diagram 1010 across private driveways where the larger marking would be impracticable, e.g. because of the narrowness of the entrance (see [2.5.4](#)).

2.5.4. Diagram 1010 is used at lay-bys, across private accesses (but see [2.5.3](#)), at acceleration and deceleration splays, and also for emphasising lane-drops. It is also used to delineate an emergency refuge area on a smart motorway and in such circumstances may incorporate raised ribs as prescribed by S11-5-41 (see also [2.6.3](#)). The marking may be supplemented with uni-directional reflecting road studs, at the spacing shown in [Table 2-5](#). Green reflectors should be used at lane-drops, along acceleration and deceleration lanes and at lay-bys (see [4.4.1](#)).

2.5.5. Further guidance on the use of diagram 1010 can be found in:

- Section 5 for major / minor junctions,
- Section 7 for grade separated junctions, and
- Chapter 3 for bus lanes, cycle lanes and tram markings.

2.5.6. Diagram 1012.1 is intended for general use to delineate the edge of carriageway, particularly on unlit classified roads and those not having clearly defined raised kerbs. It should also normally be used on all-purpose roads with hard shoulders or hard strips, on motorways (including the back edge of actively managed hard shoulders on smart motorways), unless profiled edge lines are used (see 2.6), and to delineate footways at level crossings (see Chapter 6).

2.5.7. Edge markings have merit as a safety measure despite their efficiency sometimes being impaired by dirt because of their location near the edge of the carriageway. They can also help to protect verges on narrow rural roads.

Table 2-5 Edge of carriageway markings

Diagram no. (TSRGD ref)	Width (mm)			Spacing of studs (if used) (m)	Description
	Speed limit (mph)				
	40 or less	50 or 60	70		
1009A (S11-4-8) ¹	See 2.5.3			Not used	Edge of carriageway at a field entrance or exit from a private drive onto a public road
1010 (S11-4-10) ²	100	150	200	8	Edge of carriageway at a road junction when a Give Way or Stop marking is not appropriate (i.e. at a lane diverge or merge), or exit from a private drive onto a public road, or at a lay-by (not to be used at a priority road junction where a Give Way or STOP marking should be used; see Chapter 3)
	100	150	200	See 7.4	Division between the main carriageway and a traffic lane which leaves at a junction ahead (lane-drop)
	200	200	200	Not used	Boundary between emergency refuge area and an actively managed hard shoulder on a smart motorway
1012.1 (S11-4-11)	100	100	150	Not normally used	All-purpose roads with no hard shoulder or hard strip
	150	150	200	18	All-purpose roads with hard shoulder or hard strip
	200	200	200	18	Motorways
1012.2 (S11-4-12)	200	200	200	18	Motorways
1012.3 (S11-4-13)	150 or 200	150 or 200	150 or 200	18	All-purpose roads with hard strip or hard shoulder. The 200 mm wide line must be used when there is a hard shoulder

NOTE 1: Diagram 1009A is primarily used at priority junctions, in conjunction with the Stop or Give Way marking, or at the start of a cycle lane; see Chapter 3 in each case for details.

NOTE 2: Diagram 1010 is also used to indicate the start of a bus lane or interruption of a with-flow lane at a left-turn (see Chapter 3), to show the most suitable path for vehicles through an arch bridge (see section 11) or to mark the edge of part of a carriageway used by tramcars (see Chapter 3).

NOTE 3: The prescribed colours for road studs and further guidance on spacing are detailed in section 4.

2.5.8. The marking should be laid with a gap of approximately 225 mm to the nearside edge of the carriageway. The continuous line should not be carried across the mouths of side roads, acceleration or deceleration splays, gaps in the central reservation or lay-bys, where lines to diagrams 1009A or 1010 should be used as appropriate.

2.5.9. Where the carriageway is less than 5.5 m in width, the centre line should be omitted (see [2.2.6](#)) but edge lines, where used, continued. Where edge lines are not already in use, their introduction over the length where the centre line is interrupted will help draw attention to the hazard.

2.5.10. The following are examples of situations where the edge of carriageway marking might be particularly appropriate:

- a) where the demarcation between the carriageway and the verge is poor,
- b) along lengths prone to fog and mist,
- c) on heavily-trafficked single carriageway roads where headlamp dazzle is severe,
- d) at sudden changes of carriageway width,
- e) on the approaches to narrow bridges,
- f) on the approaches to bends indicated by bend warning signs,
- g) at the back of a hard shoulder, generally 150 mm wide and laid 50 mm from the back of the hard shoulder, or
- h) at traffic calming measures e.g. chicanes.

2.5.11. Edge lines are also recommended for use along the off side carriageway edge of unlit dual carriageway roads. The line should be laid with a gap of approximately 225 mm to the central reservation. The marking should not be carried across a junction where there is a break in the central reservation; in this case a line to diagram 1010 should be used. Where there is a hard strip, edge lines should be laid as indicated in [Figure 2-18](#). They should be used on all motorways in the positions shown in [Figure 2-19](#).

2.5.12. Where, because of the traffic importance or nature of the road, clearer delineation is required, red uni-directional reflecting road studs may be used on the nearside edge (see [Table 2-5](#)) and, on dual carriageway roads, amber studs may be used adjacent to the central reservation (see [4.4](#)).

2.5.13. When depressible studs are used, they should always be placed on the carriageway side of the edge line to facilitate the cleaning action of the lenses. Non-depressible studs also benefit from trafficking to keep them free from road dirt and maintain their performance. At locations where experience has shown that placing the studs on the carriageway side of the edge line reduces their operational life to unacceptable levels, it may be better to place them behind the line. Further guidance on the use of road studs is given in section [4](#).

2.6 Raised profile edge lines

2.6.1. Raised profile lines are prescribed for use as an alternative to the edge of carriageway marking to diagram 1012.1 (S11-4-11). They consist of a continuous line marking with ribs across the line at regular intervals (see [Figure 2-7](#)). The vertical edges of the raised ribs stand clear of the water film in wet conditions, improving retroreflective performance under headlight illumination. The ribs also provide an audible vibratory warning to drivers should they stray from the carriageway and run onto the marking.

2.6.2. Two types are specified, diagram 1012.2 (S11-4-12) for use on motorways and diagram 1012.3 (S11-4-13) for use on all-purpose roads with a hard strip or hard shoulder. The base

marking must be no more than 6 mm high (S11-6-3). The upstand of the ribs above the base marking must not exceed 11 mm for diagram 1012.2 and 8 mm for diagram 1012.3. The 500 mm spacing is suitable for most edge lines laid on the main carriageway. On motorways, the 250 mm spacing is recommended for use on slip roads. The closer spacing helps to maintain the rumble effect, offsetting the likely lower speed. Closer spacing is not used on all-purpose roads as it could present a hazard to cyclists. Diagram 1012.2 is always 200 mm wide, except when used at the back of an actively managed hard shoulder (see 2.6.3). Diagram 1012.3 is usually 150 mm wide but must be increased to 200 mm when on all-purpose roads with hard shoulders (S11-5-43).

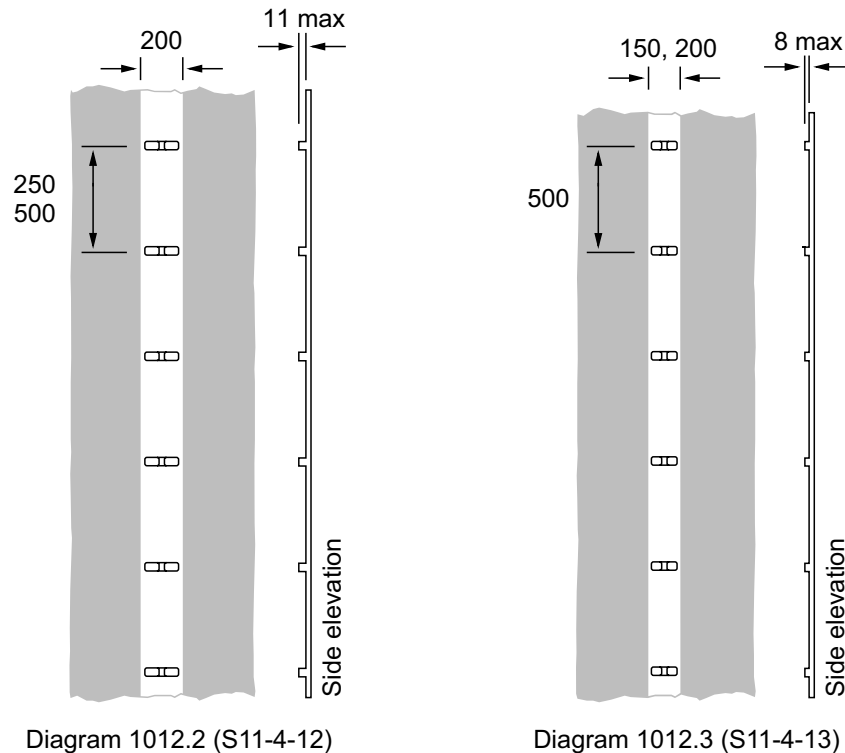

Figure 2-7 Raised profile edge lines

2.6.3. On smart motorways with actively managed hard shoulders, the marking to diagram 1012.1, not diagram 1012.2, must be used to delineate the main carriageway and hard shoulder. The marking to diagram 1012.2 may be used at the back edge of the hard shoulder, where its width must be reduced to 150 mm (S11-5-42). At emergency refuge areas, the marking to diagram 1012.2 is replaced by diagram 1010 (see 2.5.4) and this may have raised ribs, at 250 mm spacing on the individual white marks, to continue the effect of diagram 1012.2.

2.6.4. Diagram 1012.3 is used on all-purpose roads, as the more pronounced rib of diagram 1012.2 has an unacceptable effect on cyclists and pedestrians.

2.6.5. The edge lines of the following diagrams may also make use of raised profile lines:

- diagram 1040.3 (S11-4-24) – reduction of the number of lanes available,
- diagram 1040.5 (S11-4-26) – approach to a termination of the hard shoulder, and
- diagram 1042 (S9-6-22) – chevron marking, when used between main carriageway and slip road, or between bifurcating or converging carriageways (but not at a roundabout).

2.6.6. Raised profile markings must not be used as part of any marking or in any circumstances other than as specified above.

2.6.7. Raised profile markings should be discontinued where pedestrians and cyclists cross the road (e.g. at refuges) or at other places where cyclists are likely to cross them. A plain edge line

to diagram 1012.1 should be used instead. This should normally extend a minimum distance of 1 m either side of the crossing point.

2.6.8. Where gullies or similar features occur in the hard strip, cyclists may need to cross the adjacent edge line marking in order to avoid them. Any raised profile marking adjacent to such features should be replaced with a plain edge line for a distance of 10 m on each side of the gully.

2.6.9. When raised profile markings are laid on a curve of less than 1000 m radius, motorcyclists may find themselves in difficulty if there is a wide hard strip or hard shoulder and they are tempted to cross onto it. The raised ribs tend to destabilise two-wheeled vehicles on appreciable bends. If there is any concern that motor cycles might frequently cut across the line, the ribs may be omitted, although the improved night-time wet weather visibility will obviously not then be available. Embossed profiled markings are a possible alternative to rib markings (see [12.4.3](#)).

2.6.10. Drainage gaps of 100 to 150 mm should be provided at intervals of approximately 36 m where the longitudinal fall is flatter than 1 in 150, and there is a crossfall towards the profiled marking.

2.6.11. When raised profile markings are renewed, care must be taken to ensure that the rib height is not increased above the maximum height permitted by the Regulations.

2.7 Hatched markings

2.7.1. Hatched markings are prescribed as diagrams 1040, 1040.3, 1040.4 and 1040.5 (S11-4-23 to S11-4-26 respectively). They are also prescribed for use with double white lines (see section [3](#), [5.3.12](#) and [5.3.13](#)). Two sets of dimensions are prescribed where the boundary line is broken, and are as set out in [Table 2-3](#) for diagrams 1004 and 1004.1, i.e. a 4 m mark and 2 m gap where the speed limit is 40 mph or less, and 6 m mark and 3 m gap where the speed limit is more than 40 mph. Regulation 7(6) exempts these diagrams from the requirement that alternative dimensions should correspond in order to maintain the shape of the marking. This allows the width of the boundary lines to be matched to those of the centre line or warning line at either end of the hatched marking. However, the size and spacing of the diagonal marks is generally linked to the length of the boundary lines; the closer spacing and the wider diagonal mark being used with the longer boundary lines.

2.7.2. Tapers for diagrams 1040, 1040.3 and 1040.4 are specified in [Table 2-6](#). In the case of diagram 1040 on the approach to a refuge (see [2.8.1](#)), the taper should be in accordance with [Table 2-7](#) and applied to each side of the centre line, whether it is straight or curved. Diagrams 1040, 1040.3 and 1040.4 may be preceded by the deflection arrow to diagram 1014 (S11-4-14; see [Figure 2-9](#), [Figure 9-6](#), and [Table 2-6](#)). Arrows used with diagram 1040 are positioned in the centre line and not in the opposing carriageway as with double white lines, i.e. as shown in [Figure 3-2](#) and not as in [Figure 3-3](#).

2.7.3. Diagram 1040 ([Figure 2-8](#)) is intended to divide opposing flows of traffic on two-way roads. The tapered marking may be used on the approach to refuges as a more emphatic alternative to the warning line (see [2.8.1](#)). The marking with parallel boundary lines may be used to separate opposing flows of traffic where the warning line is considered insufficient at hazards such as a bend or the brow of a hill. Unless this marking starts at a physical obstruction, e.g. a refuge, it should always be preceded by the tapered marking. Where road studs are used, they must be white, and should be uni-directional. One of the boundary lines is omitted when either type of marking is placed alongside diagram 1049A (S9-6-11) or 1049B (S9-6-7) delineating a

bus or cycle lane respectively (S11-5-47). See 5.2 and 5.3 for guidance on the use of hatched markings at a road junction.

2.7.4. Diagram 1040.3 (S11-4-24, see Figure 2-9) indicates the approach to a place on a motorway, dual carriageway road or slip road where the number of lanes is reduced, or where an area of carriageway is not available to traffic. It is bounded by a 200 mm wide continuous edge marking which may be varied to diagram 1012.2 or 1012.3. It may also be varied to a width of 150 mm when used on all-purpose roads without hard shoulders (S11-5-48). The marking must always be used on the right-hand side of the carriageway; the Regulations do not prescribe a permitted variant that would allow the marking to be reversed and used on the left-hand side of the carriageway. Figure 2-9 shows the layout for a main carriageway (see Figure 7-4 for slip roads). The studs at the edge line should remain amber with red on the reverse side (see 4.4) and the spacing should be reduced to 9 m along the length of road from the first deflection arrow encountered and along the hatching. The appropriate version of the vertical sign to diagram 872.1 (S11-2-15) should also be used in advance of the taper.

Table 2-6 Taper and arrow details for diagrams 1040, 1040.3 and 1040.4

85th percentile speed of private cars (mph)	Taper (see Figure 2-9 for diagram 1040.3)	Length of arrow (m)	Distance from tip of arrow to start of taper (m)		
			First arrow	Second arrow	Third arrow (if provided)
Up to 30	1 in 40	4.5	13.75	43.75	79.75
31 to 40	1 in 40	4.5	19.75	55.75	109.75
41 to 50	1 in 45	6	21.00	66.00	138.00
51 to 60	1 in 50	6	30.00	84.00	165.00
61 to 70	1 in 55	9	37.50	91.50	190.50

NOTE: Taper is shown in Table 2-7 for diagram 1040 when used on the approach to a refuge

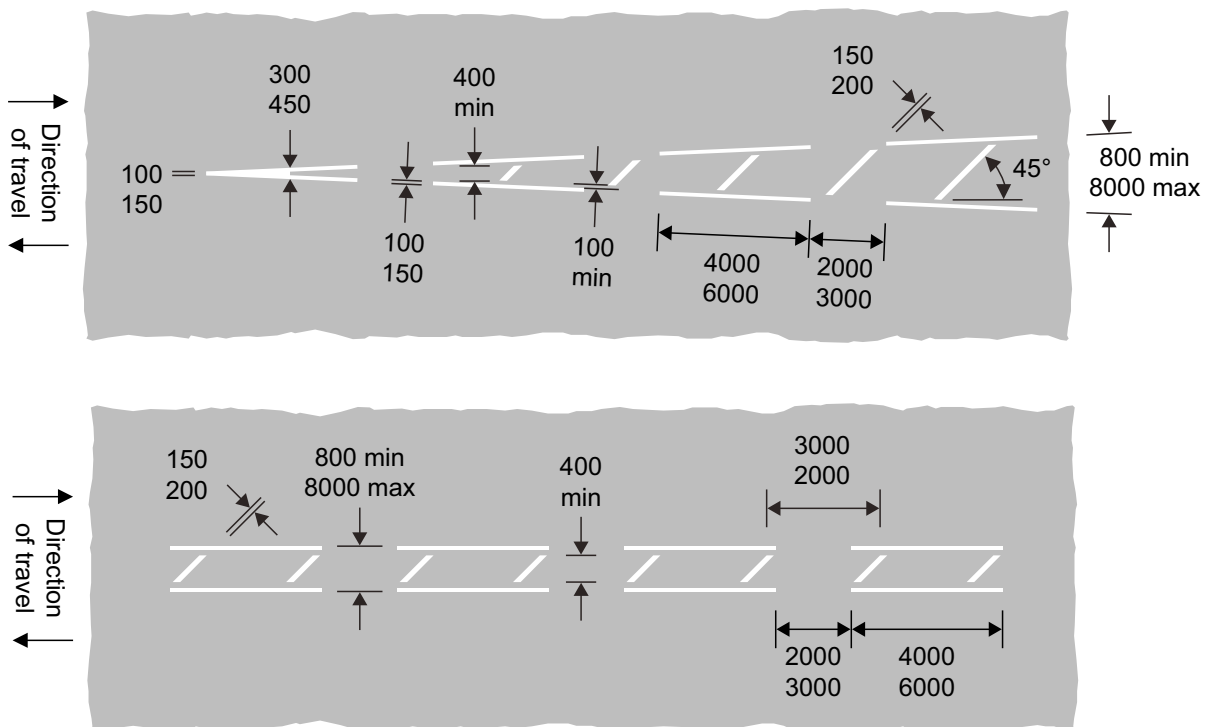

Figure 2-8 Diagram 1040 (S11-4-23) Hatched markings in the centre of a two-way road (Alternative types)

2.7.5. Diagram 1040.4 (Figure 2-10) is used to mark off an area at the edge of the carriageway which drivers should not enter unless it is safe to do so. It will commonly be used to guide traffic

past build-outs in traffic calming schemes (see section 10) and may also be placed on the off side of a cycle lane where the boundary is the line to diagram 1049B (S9-6-7). The tapers are set out in Table 2-6; the shape of the marking may be varied to suit the road geometry, provided that the dimensions prescribed in diagram 1040.4 are maintained, and it may be reversed (S11-5-49).

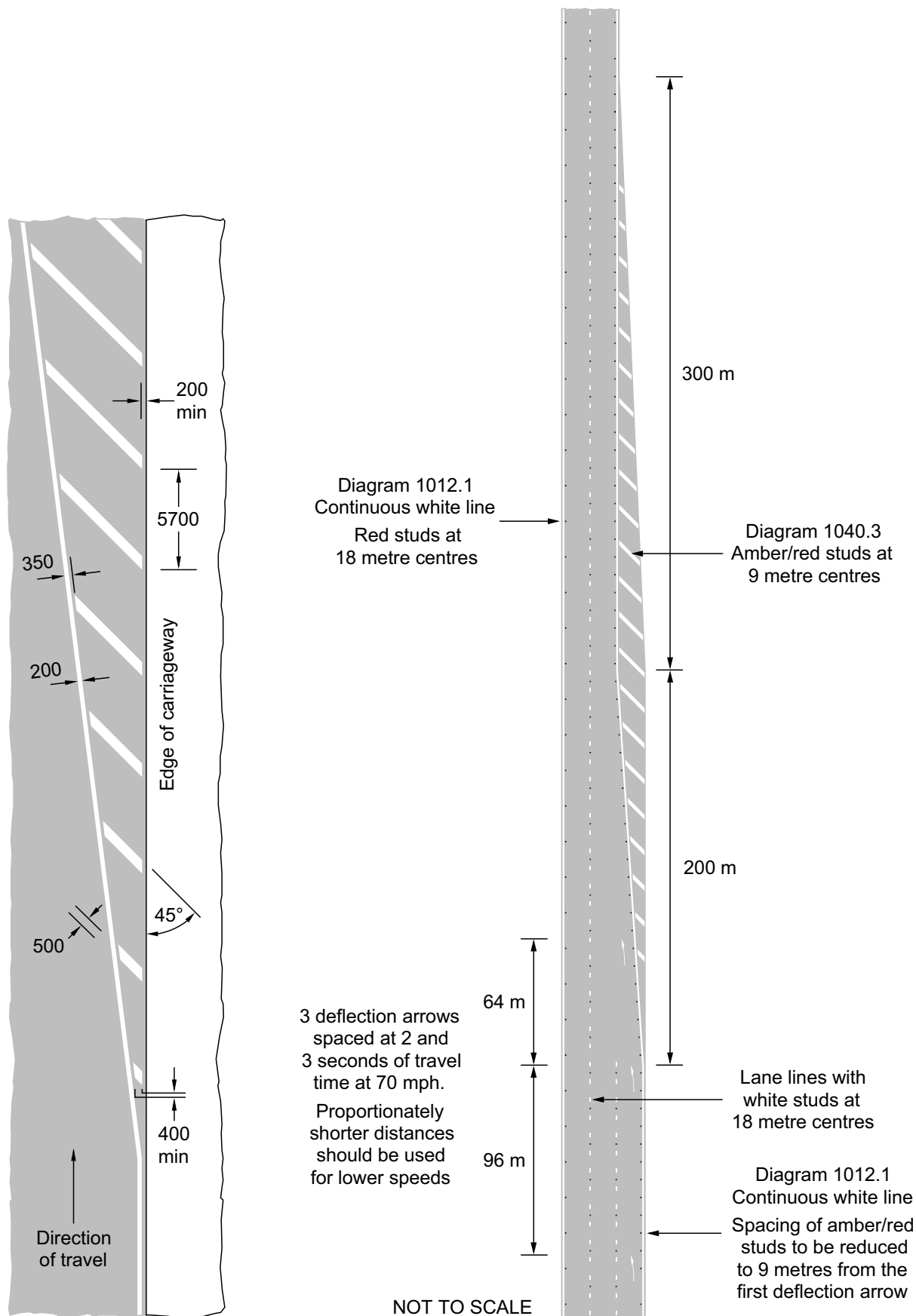

Figure 2-9 Diagram 1040.3 (S11-4-24) Loss of right-hand lane on a motorway or dual carriageway road

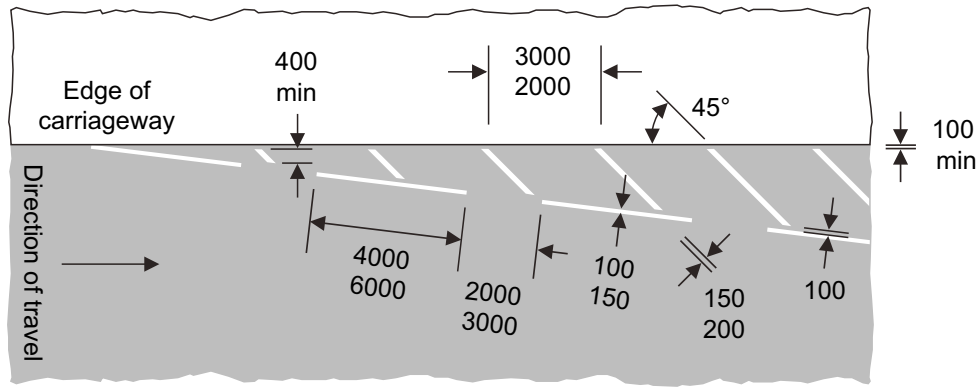

Figure 2-10 Diagram 1040.4 (S11-4-25) Area at edge of carriageway which drivers should not enter unless safe to do so

2.7.6. The marking to diagram 1040.5 (**Figure 2-11**) should be used to indicate the termination of the hard shoulder. The edge marking is always 200 mm wide, whether it is used on motorways or on all-purpose roads with full width hard shoulders. Both longitudinal lines may be formed by the marking to diagram 1012.2 or 1012.3 as appropriate (S11-5-50). The taper should normally be 1 in 15. Where there are two terminations in quick succession, the hard shoulder between them should be hatched off to discourage its use, as rejoining the motorway from the isolated section is likely to be difficult because of limited acceleration length.

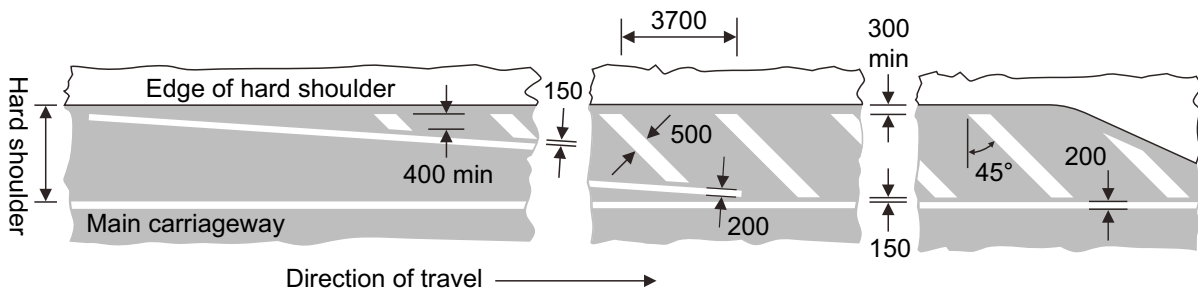

Figure 2-11 Diagram 1040.5 (S11-4-26) End of hard shoulder

2.8 Central traffic islands

2.8.1. The simplest means of marking approaches to traffic islands is to use inclined warning lines to diagram 1004 / 1004.1 (S11-4-2 and S11-4-3 respectively). Where greater emphasis is required, hatched markings to diagram 1040 (S11-4-23) may be used (see **2.7**). Details of the recommended minimum tapers are given in **Table 2-7** and guidance on the size of the markings in **2.7.1**.

2.8.2. A warning line approaching a refuge, central island etc. should always extend for the full length of the taper (see **Table 2-7**) and, if appropriate, be extended further (see **Table 2-3** for the minimum number of marks). The line should terminate in a position offset 300 mm from the edge of the refuge (see **Figure 2-12**). This may be reduced when the speed limit is 40 mph or less and there is limited width between the island and the nearside kerb, but should preferably not be less than 150 mm. Kerb faces on the refuge should not normally exceed 75 mm, because of the risk of loss of control if struck by a vehicle. Where unusually high kerbs are used, the 300 mm clearance should always be provided. The use of bi-directional road studs with diagram 1040 is not recommended, for the reasons explained in **4.1.5**.

2.8.3. Where traffic may pass on either side of an island, e.g. at a pedestrian refuge in a one-way street, a chevron marking to diagram 1041 (S11-4-27) is used (see also **2.10.3**).

2.8.4. A driver's view of an island may be obscured by other vehicles; the use of a white beacon will make its presence more conspicuous from a distance (see Chapter 4).

Table 2-7 Tapers on the approach to refuges

85th percentile speed of private cars (mph)	Preferred minimum taper	Absolute minimum taper
Up to 30	1 in 40	1 in 20
31 to 40	1 in 40	1 in 30
41 to 50	1 in 45	1 in 40
51 to 60	1 in 50	1 in 50

NOTE: The preferred minimum taper should be used wherever practicable; the absolute minimum should be used only where unavoidable.

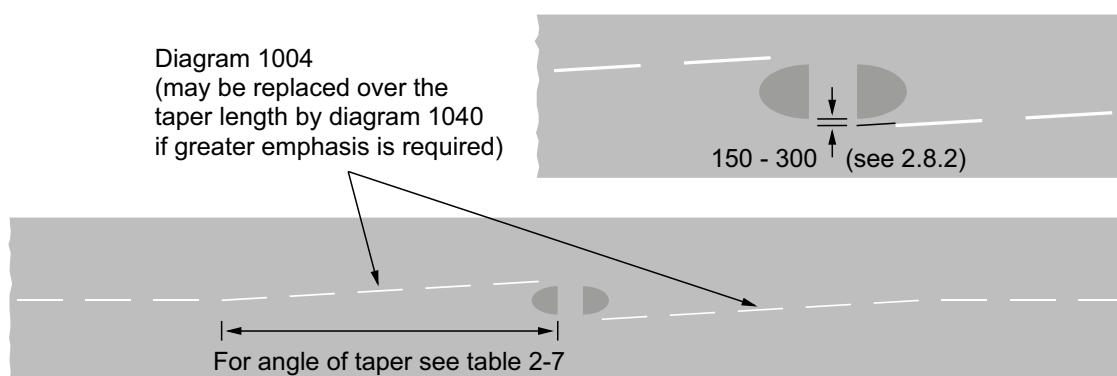
**Figure 2-12** Refuge or central island

2.9 Succession of central traffic islands

2.9.1. On four-lane single carriageway roads, pedestrian refuge islands may be provided to discourage excessive vehicle speed and help pedestrians to cross.

2.9.2. The parallel-sided version of diagram 1040 (see [Figure 2-13](#)) may be provided as a more emphatic alternative to the use of the inclined warning markings described in [2.8.2](#). The hatched marking discourages overtaking manoeuvres on the approach to each refuge.

2.9.3. Where access is required across the centre of the road to minor roads, the hatching may be omitted over a short length and replaced by a warning line to diagram 1004 / 1004.1 along the edge nearer the minor road, i.e. a continuation of the boundary line of diagram 1040. This will provide a narrow right-turn lane, the left-hand side of which is not marked (see also [5.3.5](#)). A right-turn arrow to diagram 1038 (S11-4-20) may be used in this lane, but a bifurcation arrow (diagram 1039; S11-4-22) at the entry point should not be used unless the turning lane is at least 2.5 m wide (see [5.3.9](#)). In this case the left-hand side of the right-turn lane should also be marked with a warning line to diagram 1004 / 1004.1. Marking in accordance with this paragraph helps to highlight the junction and give some protection to right-turning vehicles. If right turns into the minor road are prohibited, this can be emphasised by retaining the hatching even though vehicles may turn right out of the minor road. If the junction is with a major road and the right-turn movements cannot be prohibited then a standard design of right-turn lane will be necessary, possibly involving the dedication of the outside lane to traffic turning right (see [5.3](#)).

2.9.4. On narrower roads, the arrangement shown in [Figure 2-14](#) might be appropriate. However, the needs of cyclists must be considered; it can be intimidating if large vehicles have to pass very close in order to overtake. In addition, this layout will make passing slow vehicles difficult, and may cause problems if a vehicle breaks down. Waiting prohibitions may be needed adjacent to islands to prevent obstruction. Bus stops need to be carefully sited in relation to the island positions so as not to cause undue delays to other vehicles or invite unsafe overtaking.

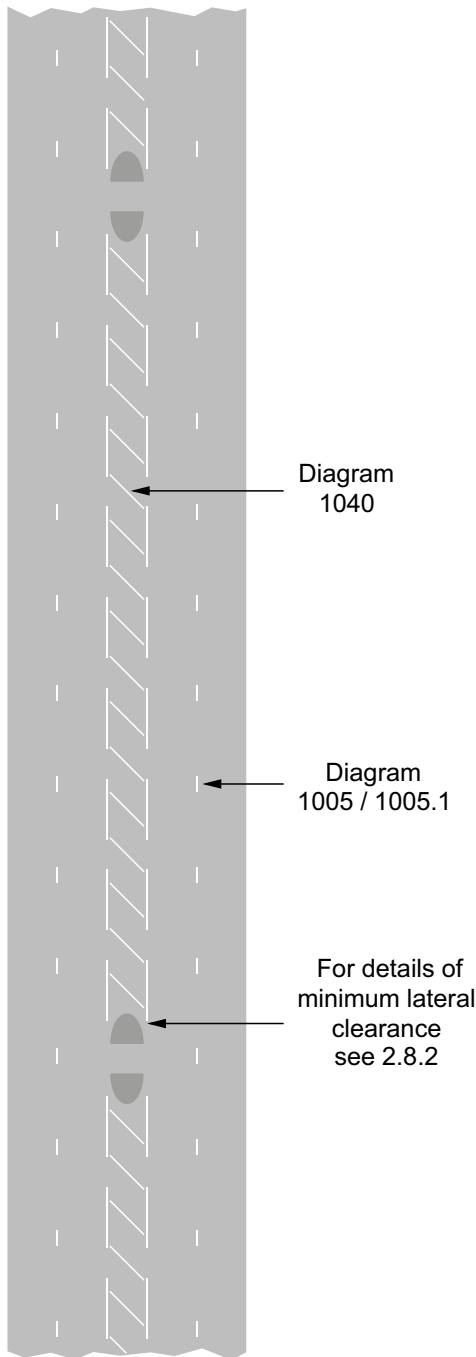

Figure 2-13 Centre of carriageway diagonal hatched marking (parallel version, full width)

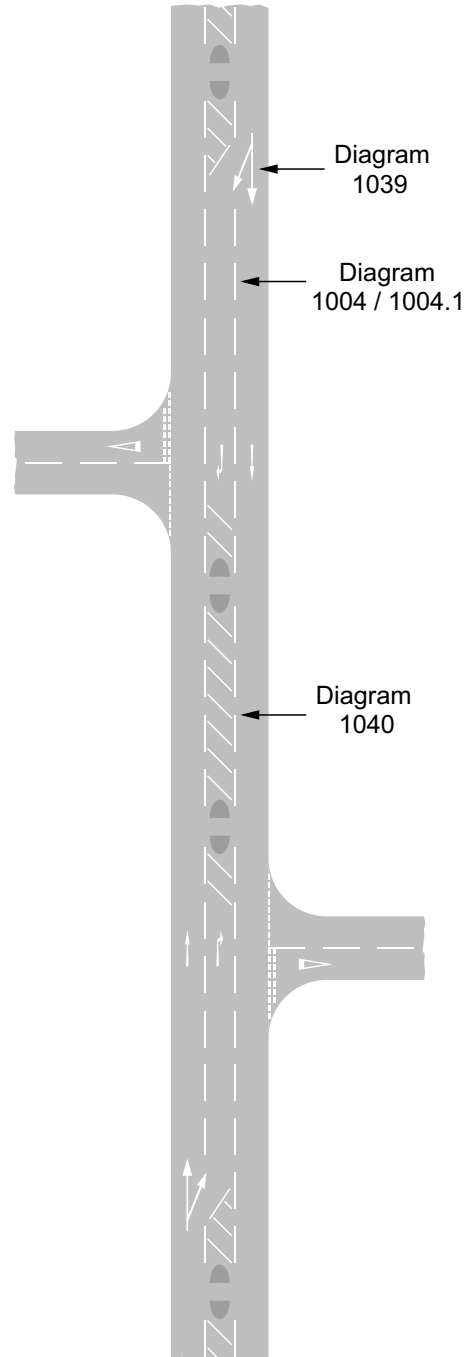

Figure 2-14 Centre of carriageway diagonal hatched marking (parallel version, narrow width)

2.10 End of dual carriageway

2.10.1. When a dual carriageway road changes to a single carriageway road other than at a junction, traffic should be guided into the slower lane when leaving the dual carriageway section. Details of appropriate vertical signing can be found in Chapter 4.

2.10.2. The reduction in the number of lanes and the taper to a single carriageway should be achieved using hatching to diagrams 1040 and 1040.4. The boundary is derived as follows (see [Figure 2-15](#)):

- a) the traffic leaving the dual carriageway section should be reduced to a single lane by marking off the outside lane at the inclinations shown in [Table 2-6](#). The full reduction should be achieved no later than the end of the central reservation, although it may occur earlier,
- b) from the point in line with the end of the central reservation, derived in a), the boundary should continue to the centre line of the single carriageway section at a taper no sharper

- than that used in a) above; if the dual carriageway section leads into a right hand bend, it might be better to use a longer taper length in order to merge tangentially with the apex,
- c) for the carriageway leading to the dual carriageway section, the boundary line should extend from the end of the taper in b) to the central reservation.

2.10.3. The lane line on the leaving carriageway (and the associated white road studs if used) should be omitted over the length of the taper, and two deflection arrows (diagram 1014) should be laid in the centre of the lane to be lost, in advance of the taper at the distances shown in **Table 2-6**. The lane line between the start of the taper and the second arrow upstream of it should be replaced by a warning line to diagram 1004 or 1004.1 as appropriate (see **2.4**).

2.10.4. If road studs are used on the dual carriageway section, nearside red studs should be continued through the merge. Amber studs should be used with the boundary line to diagram 1040.4; beyond the end of the central reservation the studs should revert to white, but be uni-directional (see **4.4.1**).

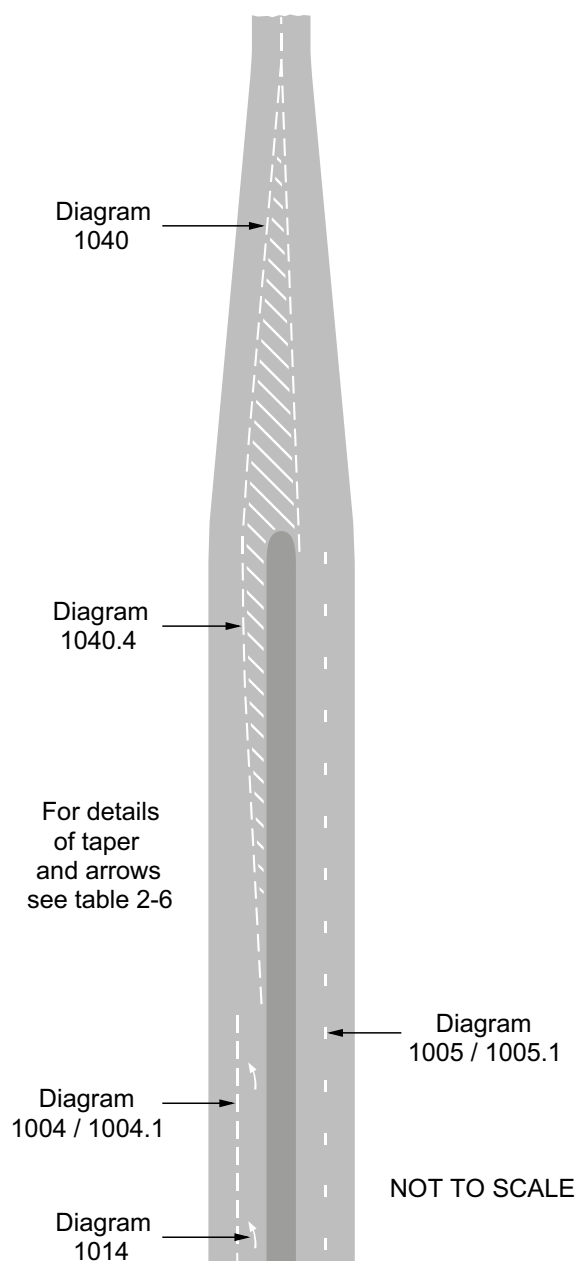

Figure 2-15 End of dual carriageway

2.11 Chevron markings

2.11.1. Diagram 1041 (**Figure 2-16**) is intended to separate streams of traffic travelling in the same direction, e.g. on the approach to a junction or to a pedestrian refuge in a one-way street. Where the marking is placed alongside a bus or cycle lane, S11-5-51 requires the boundary line adjacent to that lane to be replaced by diagram 1049A (S9-6-11) or 1049B (S9-67) as appropriate.

2.11.2. The tapered versions of diagram 1042 (**Figure 2-17**) are intended for use between a motorway or high standard all-purpose road and a slip road (see 7.2 to 7.5). They may also be used at the bifurcation or convergence of two motorways or similar roads. The parallel-sided version is used to indicate a segregated left-turn lane (see 6.8). The width of the longitudinal lines is generally 200 mm; 150 mm is likely to be appropriate when the marking is used between two lanes at a roundabout (see **Figure 6-5**) or on an all-purpose dual carriageway road without hard shoulders. Except at a roundabout, the boundary lines may be replaced with the marking shown in diagram 1012.2 or 1012.3 as appropriate (S9-8-14). It should be noted that diagram 1042 is a mandatory marking that indicates those areas of carriageway that drivers must not enter except in an emergency.

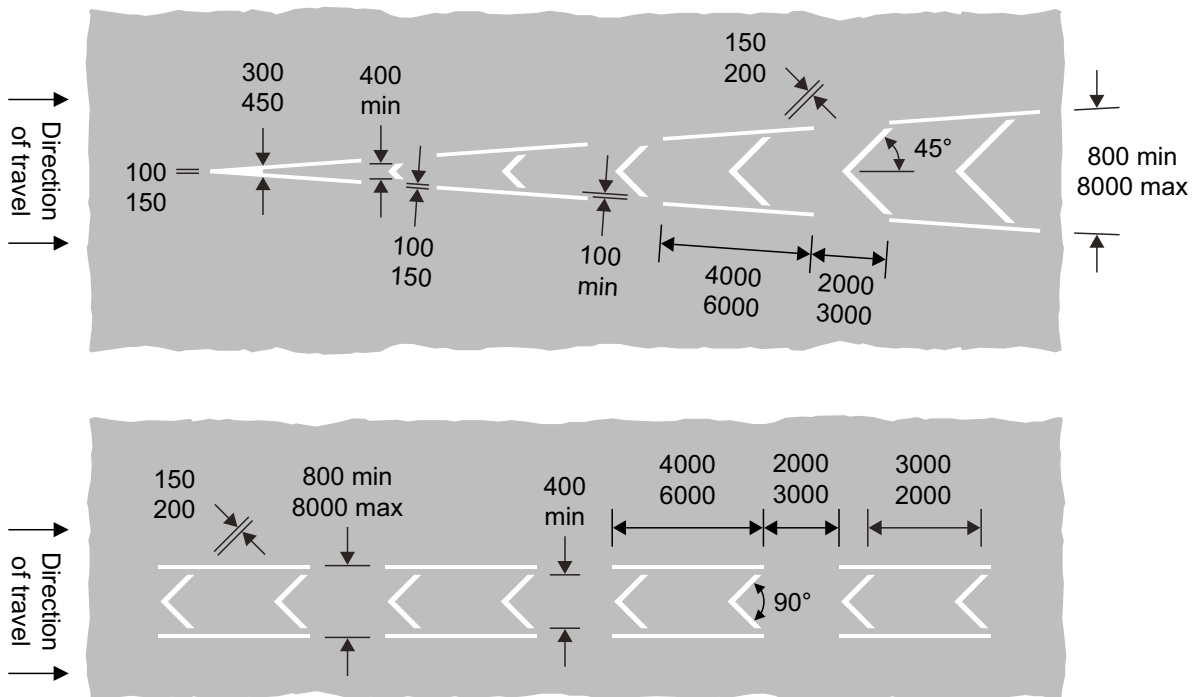

Figure 2-16 Diagram 1041 (S11-4-27) Chevron marking which drivers should not enter unless safe to do so (Alternative types)

2.11.3. The chevrons in both diagrams 1041 and 1042 must always point towards approaching traffic. Where road studs are used, these must be coloured red (see 4.4.1). Clearance between the inside edge of the boundary line and any kerb should be as indicated in 2.8.2.

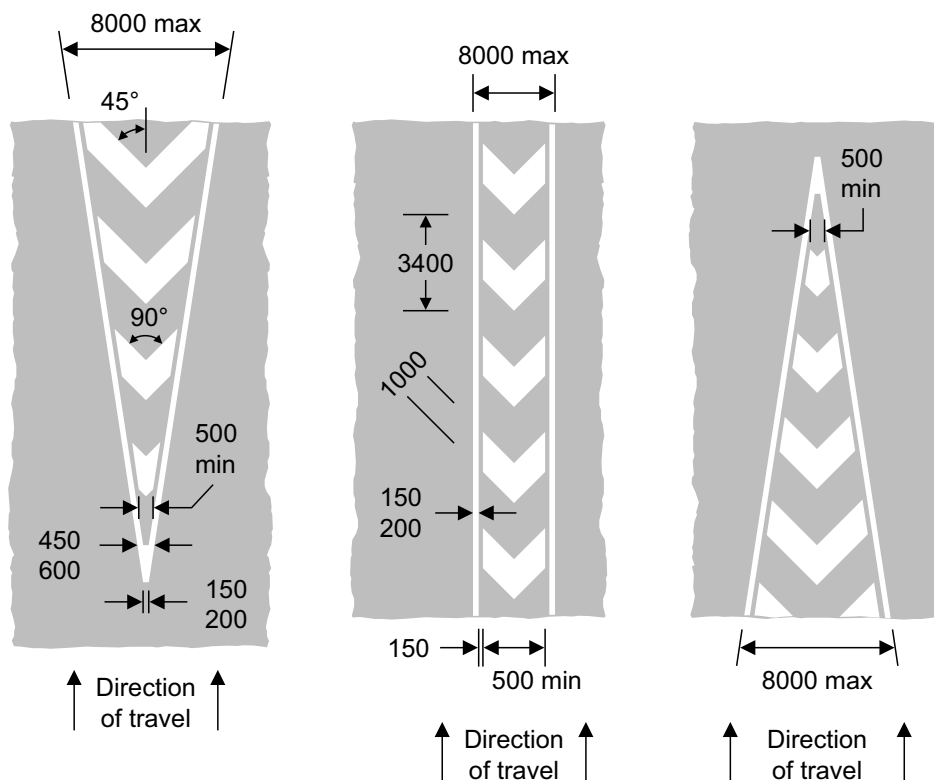
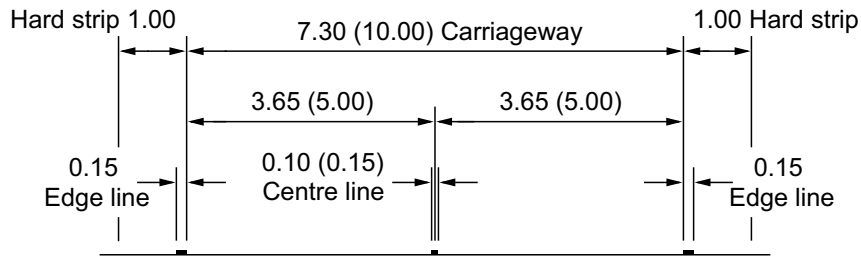

Figure 2-17 Diagram 1042 (S9-6-22) Marking which drivers must not enter except in an emergency (Alternative types)

2.12 Layout of markings between junctions

2.12.1. The layout of road markings between junctions on roads designed to TD 9 'Highway Link Design' in Volume 6 of DMRB is shown in [Figure 2-18](#) for all-purpose roads (see [2.3.5](#) and [Table 2-5](#) for guidance on appropriate lane width for dual carriageways) and [Figure 2-19](#) for motorways (see [2.3.5](#) for guidance on appropriate lane width. All dimensions in these figures are in metres. These illustrate the placing of the lines in relation to the cross-section of the road. Reference should also be made to TD 27 'Cross-Sections and Headrooms'.



All-purpose rural single carriageway road

Dimensions in brackets are for a 10 metre wide single carriageway

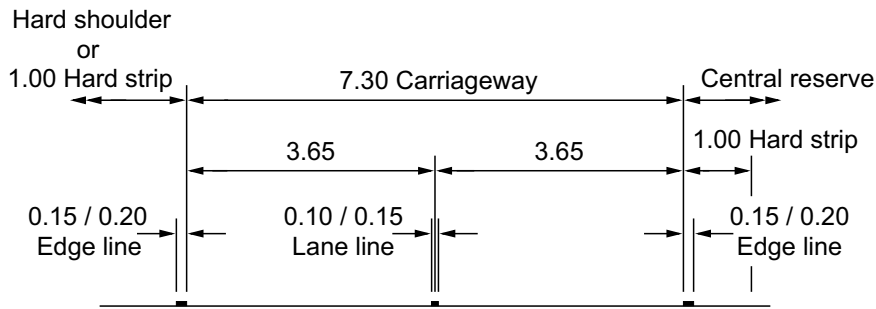

Two-lane all-purpose rural dual carriageway road

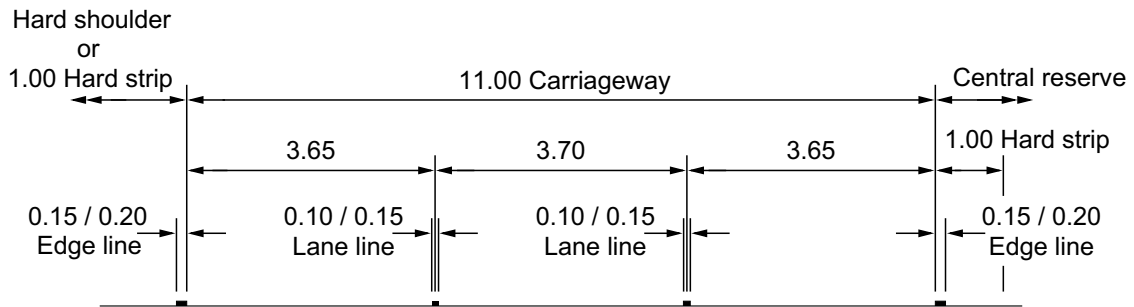

Three-lane all-purpose rural dual carriageway road

Figure 2-18 Cross-sections showing layout of road markings on all-purpose roads

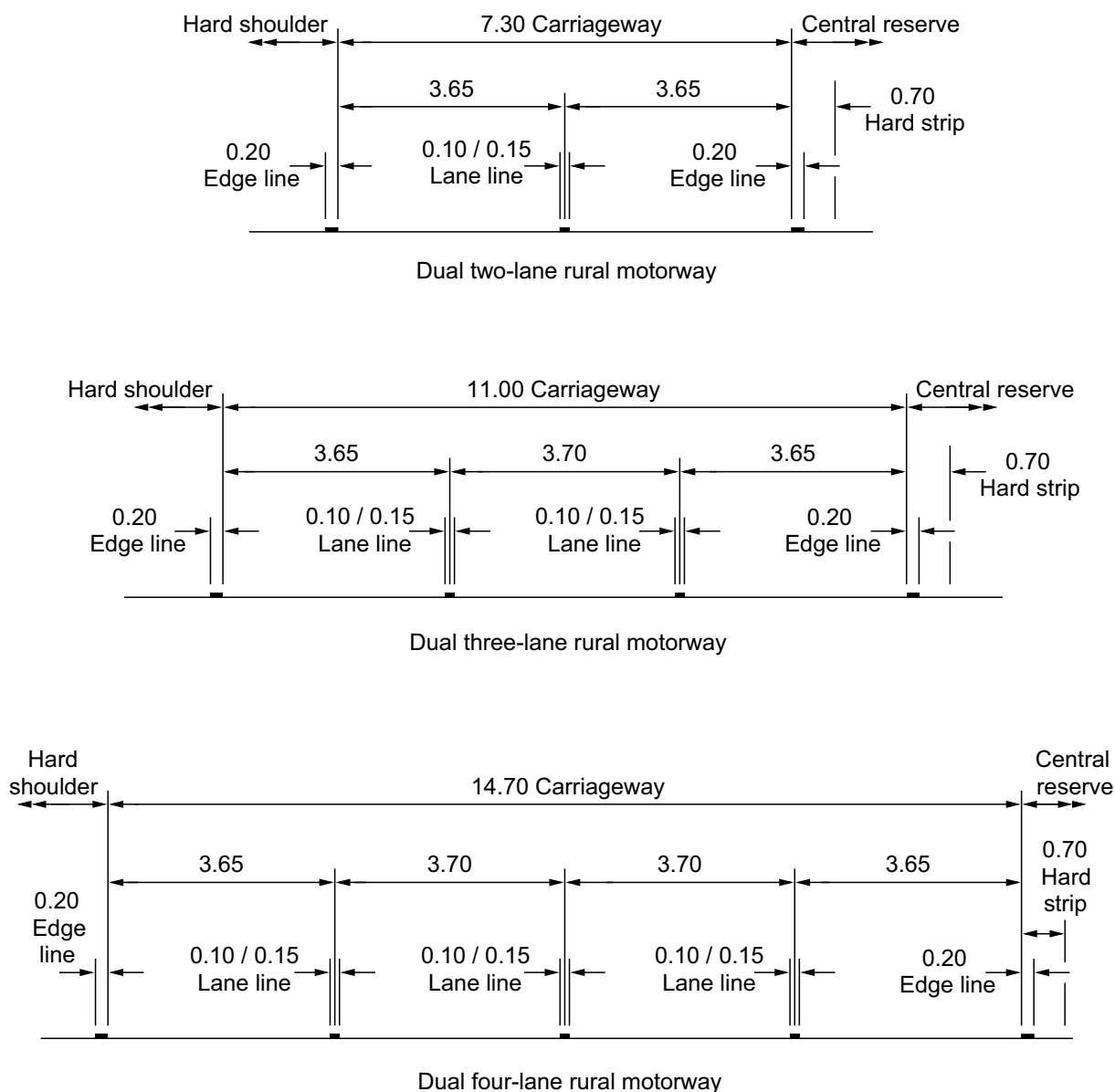

Figure 2-19 Cross-sections showing layout of road markings on motorways

2.12.2. Edge of carriageway markings between the running lanes and the hard shoulder or hard strip may use raised rib profiles (diagram 1012.2 on motorways and 1012.3 on all-purpose roads; see 2.6 for details).

2.12.3. Edge lines should be accompanied by red uni-directional retroreflecting road studs adjacent to the hard shoulder or nearside hard strip and, on motorways and dual carriageway roads, coloured amber adjacent to the central reservation. For use during contraflow working, the amber studs may have red reflectors on the opposite face. The use of road studs in conjunction with road markings is dealt with in more detail in section 4.

3.1 General

3.1.1. The double white lines shown in **Figure 3-1** are used to prohibit drivers from encroaching on that area of carriageway used by the opposing flow of traffic, generally where overtaking visibility is restricted or where a hill has a climbing lane (see 3.11 to 3.13; see 3.2.1 for recommended dimensions). Double continuous white lines may be used also in the circumstances described in 3.10 and 3.14, and at level crossings (see 3.15). Drivers may cross the line nearer to them when it is broken, but not when it is continuous. Drivers must not stop on roads marked with double white lines. The legal requirements conveyed by the markings are specified in S9-7 and S9-7-9 sets out exceptions, listing the circumstances in which vehicles are permitted to stop on a road marked with double white lines and the occasions when vehicles may cross a continuous line. The restriction on stopping applies whether the line closest to the vehicle is continuous or broken. However, on a road with more than one traffic lane in each direction the stopping restriction does not apply. A separate Traffic Regulation Order would therefore be necessary to prohibit waiting or loading on, for example, an urban four-lane road (see 3.14). Where the line closest to the vehicle is broken, the vehicle may cross or straddle the line, but only if it is safe to do so (S9-7-10).

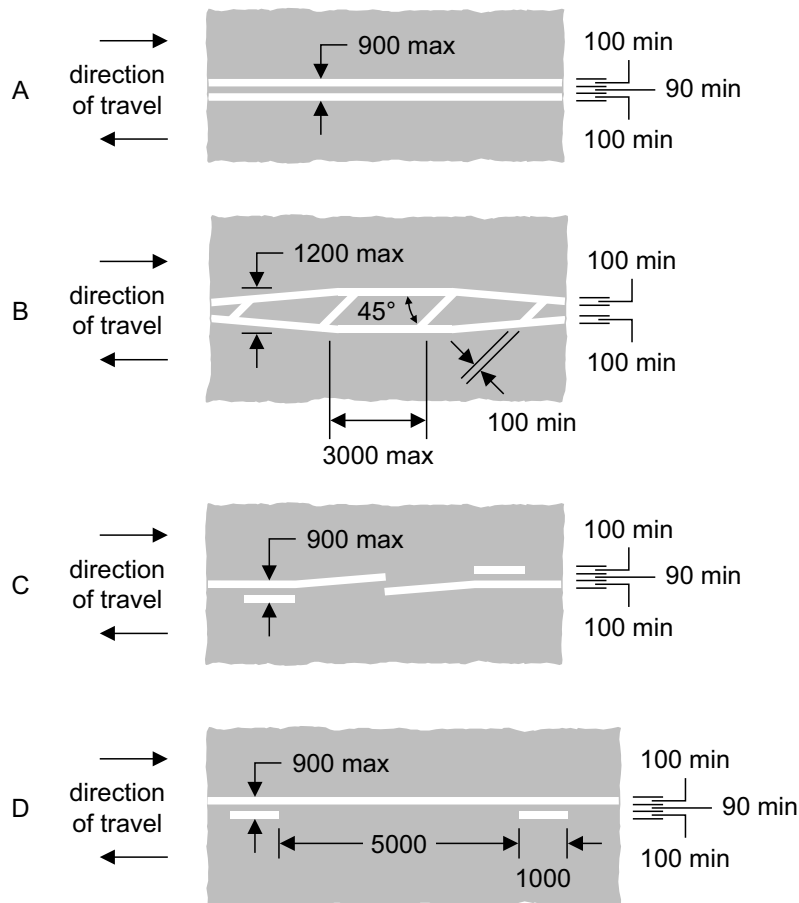

Figure 3-1 Diagram 1013.1 (S9-6-23)

3.1.2. Where double white lines are provided because visibility is restricted, each direction of travel is marked separately according to the degree of visibility in that direction. The necessary standard of visibility is governed by the speed of vehicles on the road; surveys carried out in the summer and winter months may produce differing visibility as a result of foliage growth. Where visibility is just above the minimum standard, but overtaking may nevertheless present a danger,

the warning line to diagram 1004 or 1004.1 should be used (see [2.2.3](#)). A “no overtaking” order may be imposed (see Chapter 3), but this is likely to be necessary only in very exceptional circumstances, e.g. where the carriageway is less than 6.1 m wide (see [3.1.4](#)).

3.1.3. A continuous length of double white lines, with any number of changes between continuous and broken lines in either direction, comprises a system. A double white line scheme may comprise any number of separate systems, interrupted by other types of marking (e.g. centre lines or warning lines).

3.1.4. Having regard to the road width required by buses and goods vehicles, particularly on bends, double line markings should not normally be used where the carriageway is less than 6.1 m wide; a warning line should be used instead, although a “no overtaking” order could be considered (see Chapter 3). An exception may be made where the width of a road drops marginally below 6.1 m for a short distance, and the omission of double lines at places of restricted visibility within the narrow section might be misleading.

3.1.5. Where the forward visibility is less than the desirable minimum (see [3.8](#)) it does not automatically follow that double lines should always be installed; judgement should be exercised in deciding whether, having regard to the topographical and traffic characteristics of the route, it is reasonable to impose the restrictions or whether the warning type of marking should be used instead. Double white lines are in general well respected, but they impose arbitrary restrictions on some drivers – for example those who have a better view because they are seated higher above the road. It is important that the marking is not used where the appropriate criteria are not satisfied, otherwise it will be brought into disrepute and eventually lose the respect of drivers. Routes, including those that cross traffic authority boundaries, should be considered as a whole, in order to maintain consistent standards.

3.1.6. Traffic authorities should ensure that all newly-laid double line markings conform to the criteria set out in the following paragraphs. The emphasis should always be on not using double lines except where they are clearly justified on these criteria, in relation to both the length in question and as part of the route as a whole.

3.1.7. It is not necessary to obtain formal authorisation for the lines because discretion in deciding whether to use double lines or warning lines is left to traffic authorities. However, as contravention of the prohibitory line is an endorsable offence and is subject to penalty points (section 36 of the Road Traffic Act 1988) (S9-8-1 and S9-8-2) the appropriate Commissioner of Police or Chief Constable should always be consulted whenever it is proposed to install new double line markings.

3.1.8. Double lines should not normally be used in built-up areas, as preventing vehicles from stopping could be unduly restrictive. They might, however, be required at certain difficult positions, on three-lane hills (see [3.11](#) to [3.13](#)) or at level crossings (see Chapter 6).

3.2 Description

3.2.1. Double lines consist of a continuous prohibitory line accompanied either by another continuous line or by a broken permissive line to provide for the different forward visibilities in opposite directions. The broken line comprises 1 m marks with 5 m gaps. The two lines are normally spaced 175 mm apart (minimum 90 mm). The Regulations require each line to be a minimum of 100 mm wide, but 150 mm should normally be used. The overall maximum width of both lines and the gap between them must not exceed 900 mm. If a wider marking is required, version B prescribed in diagram 1013.1 (see [Figure 3-1](#)) may be used, with a maximum overall width of 1200 mm. The version B marking usually tapers at each end to connect with version A, but may abut diagram 1013.5 (S9-6-24, see [3.10](#)) or diagram 1040 (S11-4-23). Note that

the diagonal line in the version B marking meets the longitudinal lines; there is no gap as with diagram 1013.5 or 1040.

3.2.2. All double white lines must be laid in reflectorised material (S9-8-13). Raised rib markings (see [2.6](#)) must not be used. When laid in the nominal centre of the carriageway, double white lines should be placed either symmetrically about the centre line or with the continuous line along the centre. The former arrangement would make a new installation cheaper when road studs (particularly the depressible type) are already in use. However, if the road is narrow, the latter layout could be used to give extra width to the side with the prohibitory line (see also [3.1.4](#)).

3.3 Road studs

3.3.1. S9-8-10 requires double white line systems to be fitted with road studs. Except in the circumstances detailed in [3.3.2](#), a single row of white bi-directional reflecting or light emitting road studs is placed between the lines at centres between 3 m and 4.5 m. Other than at level crossings, where a spacing of 4 m should be used (see Chapter 6), it is recommended that a 4.5 m spacing is adopted on all new installations. Provided they are within the above range of dimensions, it is not necessary to change existing installations to 4.5 m spacing merely to comply with this paragraph.

3.3.2. Where the road marking is that shown in version B of diagram 1013.1, the studs may be fitted in opposite pairs, within the width of each of the two lines, as an alternative to a single row between them (S9-8-10(4)). This is likely to be appropriate when the continuous lines are more than 175 mm apart. Studs, when fitted in pairs, should be uni-directional so that only the line of studs nearer to the driver is fitted with reflectors or source emitting white light (during the hours of darkness) that can be seen by that driver.

3.4 Deflection arrows

3.4.1. At least one arrow to diagram 1014 (S11-4-14, see [Figure 9-5](#)) should be placed in advance of the start of any continuous line which is on the driver's side, to warn of the approaching restriction (see also [3.4.4](#) and [3.6](#)). If space permits, two arrows should normally be provided. Where a driver's forward view of the road surface is limited, as at a crest, a third arrow may be necessary to give adequate forewarning (see [Figure 3-2](#)).

3.4.2. Deflection arrows on the approach to a double white line system (see [3.1.3](#)) are usually positioned in the centre of the carriageway (see [Figure 3-2](#)) replacing one of the centre line marks. Where the centre is marked using the parallel-sided version of diagram 1040 (see [Figure 2-8](#)), the omission of a pair of edge marks and the associated diagonals will emphasise the arrow. Where arrows are required within a double white line system, they should be positioned approximately 500 mm to the right of the continuous line in order to avoid breaking the double white line pattern (see [Figure 3-3](#)). All arrows on each approach must be in line with one another.

3.4.3. The first arrow should normally be placed a distance in advance of the start of a continuous line equivalent to one second of travel, the second arrow at a point equivalent to a further two seconds of travel, and the third, where necessary, at a point equivalent to a distance of a further three seconds of travel. The spacing for various speeds given in [Table 3-1](#) has been adjusted to fit the standard modules so that the arrow is positioned equidistantly between two warning marks.

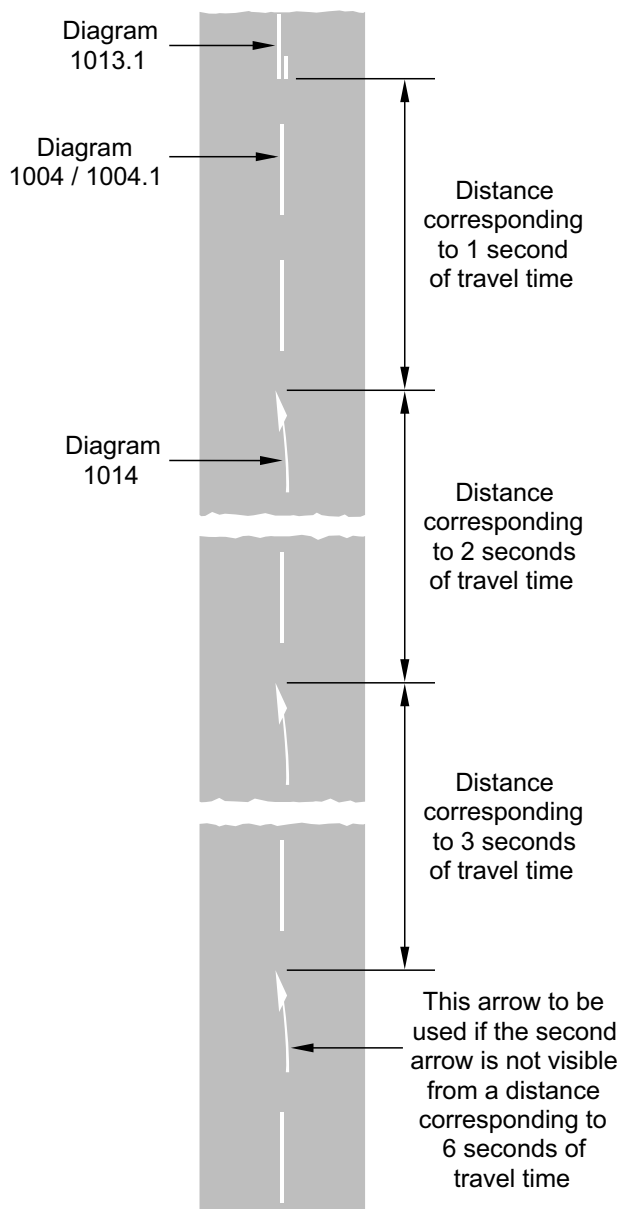

Figure 3-2 Warning arrows on approach to double lines on a two-lane carriageway

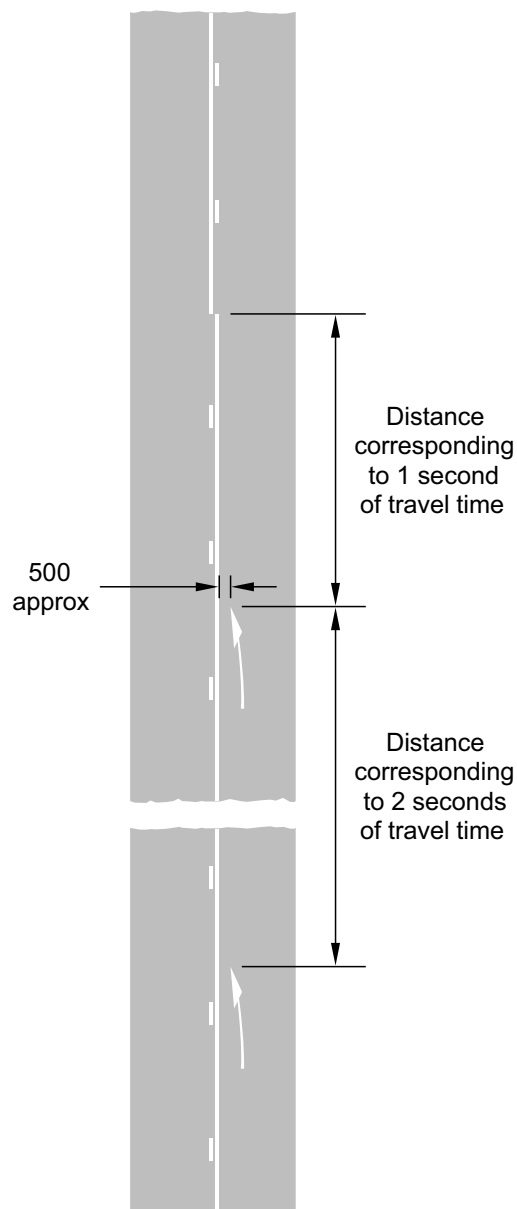

Figure 3-3 Warning arrows within a double white line system

Table 3-1 Location of deflection arrows

Speed limit (mph)	Length of arrow(m)	Distance of tip of arrow from the start of the unbroken line (m)		
		First arrow	Second arrow	Third arrow
30	4.5	13.75	43.75	79.75
40	4.5	19.75	55.75	109.75
50	6	21.00	66.00	138.00
60	6	30.00	84.00	165.00

3.4.4. Deflection arrows are not required where the continuous line is interrupted at a junction or at a refuge (see also 5.3.12). They are also not required if a continuous line commences immediately after the point where a central reservation ends, or immediately after a roundabout. However, in the latter case the use of an arrow, as indicated in Figure 3-4, might be beneficial. Should two traffic lanes continue beyond the exit of a roundabout (i.e. on a three- or four-lane carriageway), an arrow is not required.

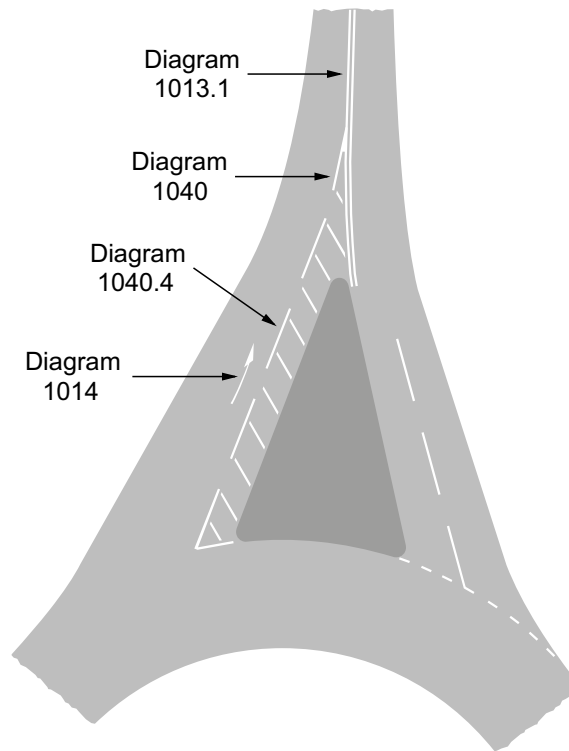

Figure 3-4 Use of deflection arrow at exit from a roundabout

3.5 Splayed markings on bends and crests

3.5.1. To increase the lateral separation of opposing traffic on sharp bends or crests, double continuous lines, where they are justified, may be splayed with a maximum overall width of 1200 mm (diagram 1013.1 version B); if greater widths are required, diagram 1040 should be used with one of the boundary lines replaced by diagram 1013.1 version A (permitted variant in S11-5-47, see [Figure 5-8](#) and [Figure 5-9](#)). It is essential that there is adequate clearance on each side to enable vehicles to negotiate the bend or hump without crossing the lines. In version B, the double white lines should be opened out at a taper no sharper than 1 in 50; the area between them must be hatched with marks of the same width as the longitudinal lines, at spacings of not more than 3 m. On a crest, the lines should attain maximum width at the point of least visibility (not always the highest point) in each direction. This hatched marking may be used only between double continuous lines, never between a continuous and a broken line.

3.6 Inclined lines at refuges and traffic islands

3.6.1. Double lines should not be splayed where they meet a refuge or traffic island. Both lines should be inclined to the driver's side of the feature, keeping them parallel to each other so that traffic is guided safely past the feature (see [Figure 3-5](#)). Guidance on the appropriate offset between the line and the feature can be found in [2.8.2](#). Lines should not be continued alongside the feature. Recommended tapers are set out in [Table 2-7](#). Where a feature interrupts a continuous line, warning arrows are not required at the recommencement of the marking after the refuge. If on the approach to a feature the line on the driver's side is broken, it should be replaced with a continuous line back from the feature over the desirable minimum visibility distance (V) given in [Table 3-2](#). This avoids inviting an unsafe overtaking manoeuvre.



For angle of taper see table 2-7

Figure 3-5 Use of inclined lines at a refuge

3.7 Road junctions

3.7.1. Improved visibility sometimes results in reversion to a broken line on the approach to a junction. In such cases, it is better to maintain the continuous line beyond the junction to avoid encouraging overtaking at an unsuitable point.

3.7.2. The Regulations permit vehicles to cross the continuous line to enter any other road or private access (S9-7-9(5)). A gap in the line is not therefore necessary. However, where there is a dedicated right-turn lane this should be marked out as shown in [Figure 5-7](#) and described in [5.3.12](#). Deflection arrows are not required at the recommencement of the double line either side of the junction.

3.7.3. The use of double white lines in conjunction with a right-turn lane on a road with a climbing lane is dealt with in [5.3.13](#).

3.8 Visibility distance

3.8.1. Visibility distance is defined as the maximum distance at which an object 1.05 m above the carriageway can be seen by an observer at the same height, taking account of vertical as well as horizontal curvature. In [Table 3-2](#), for each speed interval, V is the desirable minimum visibility distance and W is the warning line visibility distance as measured between points on the centre of the carriageway. Warning lines are laid where overtaking is potentially hazardous, but visibility is not so restricted that overtaking needs to be prohibited (see [2.4](#)).

Table 3-2 Visibility distance

85th percentile speed of private cars (mph)	Desirable minimum visibility distance V (m)	Warning line visibility distance W (m)
Up to 30	75	115
31 to 40	95	160
41 to 50	120	195
51 to 60	150	240
Over 60	175	275

3.9 Design procedure for two-lane roads

3.9.1. Double white line systems (see [3.1.3](#)) should not be designed entirely on the basis of plans and sight distance data. A site visit should always be made, and other relevant information such as the accident record taken into account. The complete scheme, with all adjustments, deflection arrows and associated markings should then be designed on a large-scale plan before any markings are laid on the road. The visibility distances used to determine the double line scheme should be based on actual traffic speeds, not the speed limit. It should be noted that the values for V and W shown in [Table 3-2](#) are not interpolated within a particular speed range, e.g. for an 85th percentile speed of 45 mph, V and W are 120 m and 195 m respectively.

Step 1 Determine traffic speeds along the section for each direction of travel. From [Table 3-2](#), find the desirable minimum visibility V for each part of the section, in each direction.

Step 2 For one direction of travel, mark each of the points where desirable minimum visibility distance V is lost, and where it is regained. Each of these pairs of points can now be joined by a continuous white line to create a series of line segments, except where such a segment would be shorter than $V / 4$, and would be separated from its preceding and succeeding segments by at least the relevant V (note 1(a) below); such short isolated segments should not be marked as continuous unless there is very good justification for retaining them.

Step 3 On the exit from a left hand bend, the continuous line should be extended until the warning line visibility distance W is attained, or the road ceases to curve to the left, whichever results in the shorter line.

Step 4 Gaps shorter than the relevant V (note 1(a)) between continuous line segments should be closed by extending the continuous line.

Step 5 Repeat Steps 2, 3 and 4 for the other direction of travel.

Step 6 On the plan, mark broken lines alongside remaining single continuous lines, on the appropriate side (i.e. on the side for the direction of travel in which a driver has visibility better than V). This will result in the creation of a number of lengths of double white lines.

Step 7 If the gap between two lengths of double white line systems is shorter than half the relevant V value (notes 1(b) and 2 below), the systems should be extended, without a change in pattern, to fill the gap. Normally the systems would meet in the middle of the gap, but the designer should adjust the point of meeting to minimise loss of length from overtaking sections (note 3), or to avoid the release of traffic at an unsuitable point.

Step 8 If this joining of systems results in a length of broken line within the resulting system (i.e. not at one end) that is shorter than the relevant V (note 1(a)), then that length of broken line should be replaced by a continuous line.

Step 9 If the gap between two systems is greater than half the relevant V (note 1(b)), but less than the relevant W (note 4), warning lines should be laid in the gap between the systems.

Step 10 If traffic leaving a length of double white lines is subject to a continuous line that extends beyond the point where the continuous line for traffic in the other direction starts, and it seems that this might cause confusion, the inbound continuous line may be started sooner, at the designer's discretion.

NOTE 1(a) In a particular direction, the relevant V value for a gap between two continuous lines is taken to be the same as that used to determine the start of the continuous line after the gap.

NOTE 1(b) When considering the gap between two systems, if the application of note 1(a) results in a different V in each direction, the greater value should be used.

NOTE 2. $V / 2$ is used in Step 7 in preference to V to avoid excessive lengths of unnecessary continuous line. Overtaking lengths less than V that might arise are closed later, at Step 8.

NOTE 3. When adjusting the meeting point of systems, the designer should take account of the availability of other (perhaps safer) overtaking opportunities in the vicinity.

NOTE 4. The relevant W value at any point is taken to be that for the speed corresponding to the relevant V value at that point, defined under 1(a) and 1(b) above.

3.9.2. The above procedure achieves the following:

- a) the minimum length for an overtaking stretch is V ,
- b) the minimum length for a broken line element within a system is V , and
- c) the minimum length for a stretch of warning line between two systems is $V / 2$.

This minimises both frequent changes of pattern and the length of continuous line put down at places where visibility is adequate.

3.10 Three-lane roads

3.10.1. On some rural wide single carriageway roads it might be desirable to create overtaking sections by providing two lanes in one direction and a single lane in the other. The division between the opposing traffic lanes is marked by double white lines to diagram 1013.1 version B (see [Figure 3-1](#)). Hatched road markings to diagram 1013.5 (S9-6-24, see [Figure 3-6](#)) are used in the centre of the road where the overtaking lane changes from one direction of travel to the other. These markings have continuous white line boundaries and have the same regulatory requirements as diagram, 1013.1 (S9-7-9). Upright signs to diagrams 887 to 891 (S11-2-16 to S11-2-20 respectively) are used in conjunction with these markings. Details of design principles and road layouts can be found in TD 70 'Design of Wide Single 2+1 Roads'. This standard is not appropriate for isolated three-lane hills (see [3.11](#) to [3.13](#)).

3.11 Three-lane hills

3.11.1. A three-lane hill (see [Figure 3-7](#)) is intended to provide two lanes for ascending traffic so that faster-moving vehicles may overtake slower ones in safety. The downhill traffic may be fully confined to one lane, or partially confined if overtaking is permitted. The left hand uphill lane should be a continuation of the nearside lane, with the widening to the right, so that slower vehicles do not have to change lanes at either end. The procedure for marking three-lane hills, set out below, is designed to result in markings that allow downhill overtaking only at those locations where visibility is extensive in both directions.

3.11.2. A three-lane hill is marked with a lane line (diagram 1005 or 1005.1) separating the two uphill lanes, and a double white line separating them from the downhill lane (see [Figure 3-7](#)). Where the carriageway width is the standard 10 m (excluding any edge strips) it should be marked so that the uphill climbing lane is 3.2 m wide and the other lanes each 3.4 m wide. Further details are to be found in TD 9 'Highway Link Design'.

3.11.3. The double white line will always feature a continuous line on the side of the uphill traffic. On the downhill side, where certain criteria are met, the line may be broken to permit overtaking. These criteria are determined as follows:

- a) establish the 85th percentile traffic speed for the downhill direction, and determine from [Table 3-2](#) the appropriate warning line visibility distance W ,
- b) measure downhill visibility with the observer on the proposed alignment of the double white line, but with two targets, one on the proposed alignment, and the other on the lane line separating the two uphill lanes. The visibility criteria are satisfied only when both targets are simultaneously visible at a distance W from the observer, and when no part of the sight line to the target on the lane line at any point passes over the inside uphill lane (where it could be obscured by an uphill vehicle). This ensures adequate forward vision for a driver in either direction who intends using the centre lane to overtake,
- c) a broken line is installed for downhill traffic only where the criteria in Step 2 of [3.9.1](#) are satisfied, and only if it can be installed for a minimum length W . Otherwise a continuous line is used to prohibit downhill overtaking.

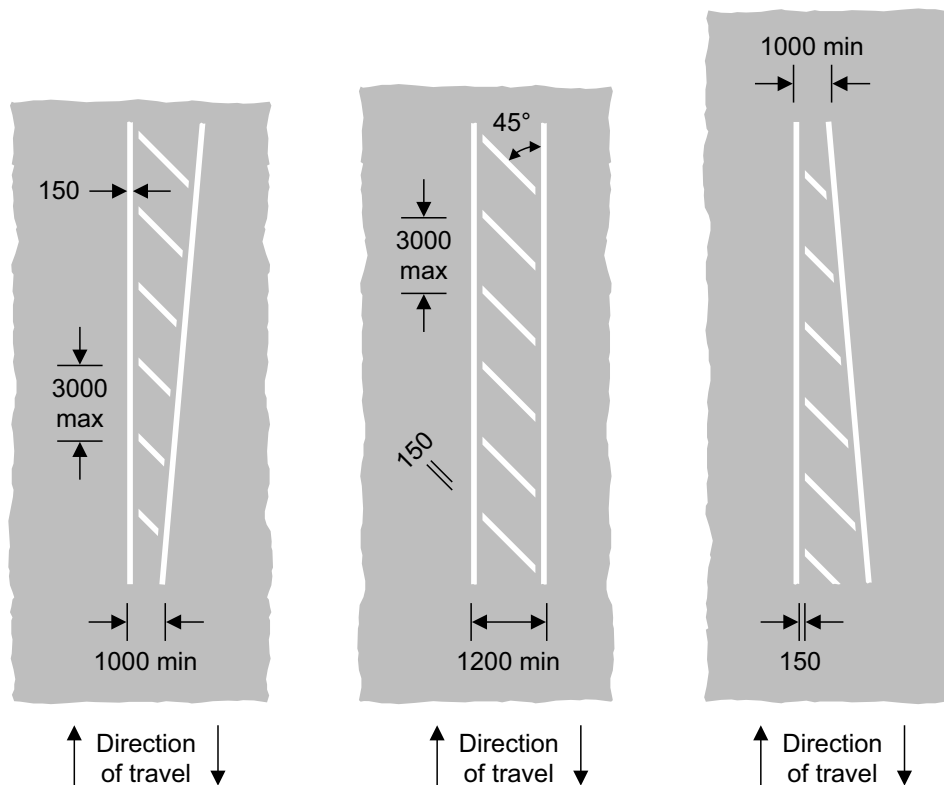

Figure 3-6 Diagram 1013.5 (S9-6-24) (Alternative types)

3.11.4. To avoid frequent changes of pattern on long hills, or for safety reasons, the designer may on occasion use a downhill continuous line even when the visibility criteria for a broken line in Step 2 are satisfied, although the use of a prohibitory line on long straight sections should be avoided if possible.

3.11.5. The marking at the commencement of the climbing lane is designed to encourage uphill drivers to keep to the nearside lane unless overtaking. In order to avoid a potential conflict at this point between uphill and downhill overtaking traffic, a length of double continuous line should be provided for a length equal to W in [Table 3-2](#) for the speed of the uphill traffic. This ensures that any downhill overtaking vehicle will be returned to the nearside lane before coming into conflict with an uphill vehicle beginning an overtaking manoeuvre at the start of the climbing lane (see [Figure 3-7](#)). In addition, the double white line may be extended to divide opposing traffic over the taper in order to prevent overtaking by downhill traffic. However, if visibility over this length is good, then observance may be poor and a warning line might be more effective.

3.11.6. This procedure will still allow downhill overtaking on long straight, or nearly straight, hills. It will restrict it elsewhere, particularly in those cases where visibility is poor for an uphill nearside lane vehicle trying to pull out from behind a large vehicle.

3.11.7. The alignment at the end of a climbing lane should place the onus on the overtaking driver to rejoin the nearside lane (see [Figure 3-7](#)). Care should be taken to ensure that the return to a single lane does not occur where junctions or sharp curves may cause problems. Signs to diagram 872.1 (S11-2-15) should also be used (see Chapter 4).

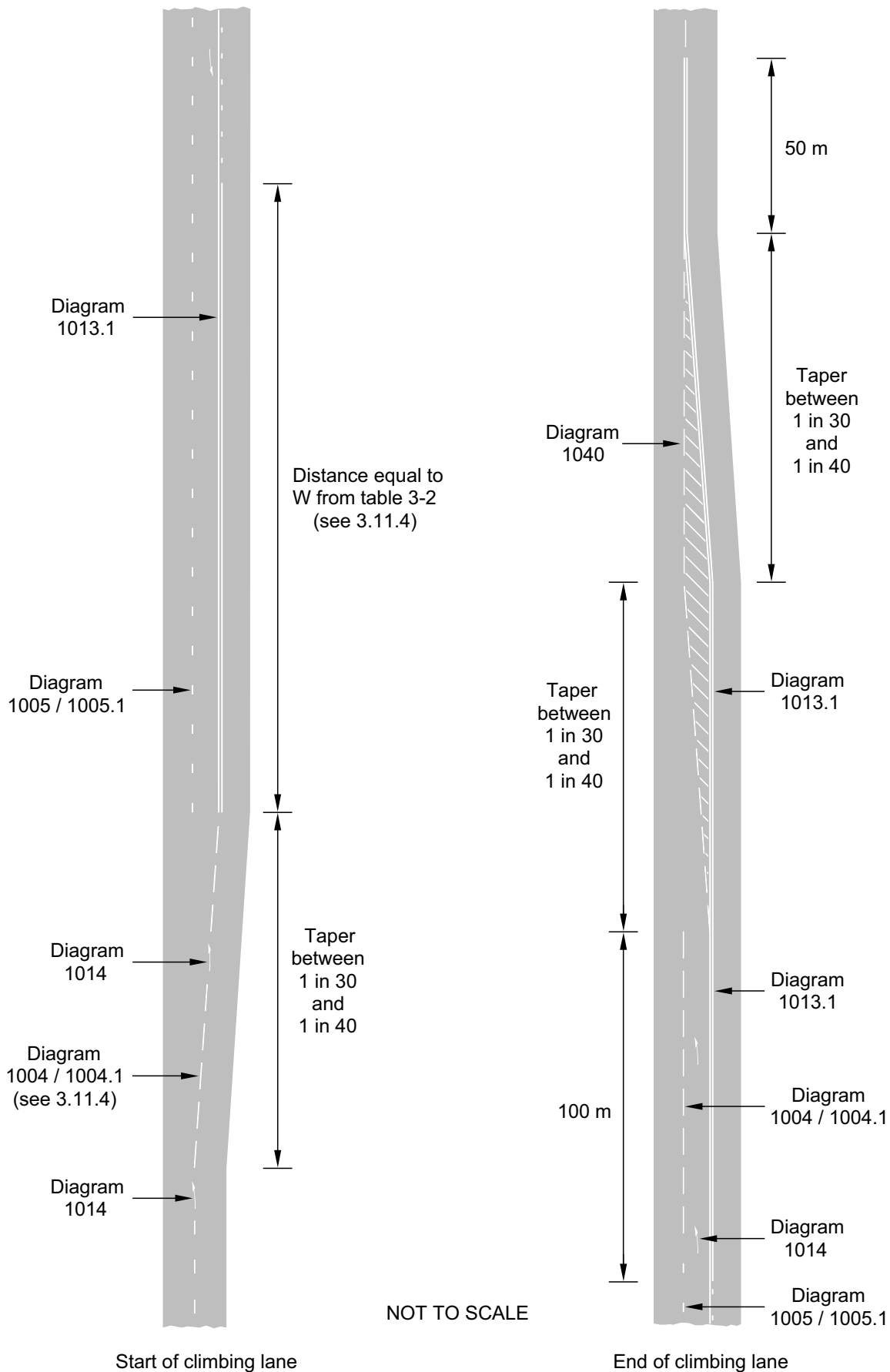

Figure 3-7 Road markings for start and end of climbing lane

3.12 Layout at crests

3.12.1. Where there are climbing lanes on both sides of the hill and the road has been widened on the crest to 13.2 m, as indicated in TD 9 'Highway Link Design' then:

- a) if the length of 13.2 m wide carriageway (including any hatched area) between the tapers is 500 m or more, a conventional layout should be used between the tapers,
- b) if the length of 13.2 m wide carriageway between the tapers is less than 500 m, the climbing lanes should overlap as shown in [Figure 3-8](#). In this case the distance between the tapers (i.e. the length of 13.2 m carriageway including hatching) should not be less than 200 m.

3.12.2. If the carriageway over the crest remains unchanged in width at 10 m, the marking layout shown in [Figure 3-9](#) should be adopted.

3.13 Layout at sag curves

3.13.1. Where there are climbing lanes on both sides of a sag curve, a conventional two-lane road layout may be used to link them, provided this is at least 500 m in length between tapers. For shorter lengths, the intervening carriageway should be maintained at 10 m wide and the climbing lanes extended downhill until they meet, using a road marking to diagram 1013.1 version B (see [Figure 3-10](#)). The taper in the version B marking (see [Figure 3-1](#)) should not be sharper than 1 in 50.

3.14 Four-lane roads

3.14.1. On single carriageway roads with two or more lanes in each direction, the centre may be marked with a double continuous line irrespective of visibility. This should eliminate the possibility of a vehicle overtaking in one direction being confronted by an opposing vehicle which is “double overtaking” by crossing the centre line. The stopping restriction imposed by double white lines does not apply in this case (see [3.1.1](#)).

3.15 Level crossings

3.15.1. Double white lines are used at some level crossings even when the conditions do not meet the visibility criteria in [Table 3-2](#). Markings should be installed at level crossings only after consultation with the Office of Rail and Road.

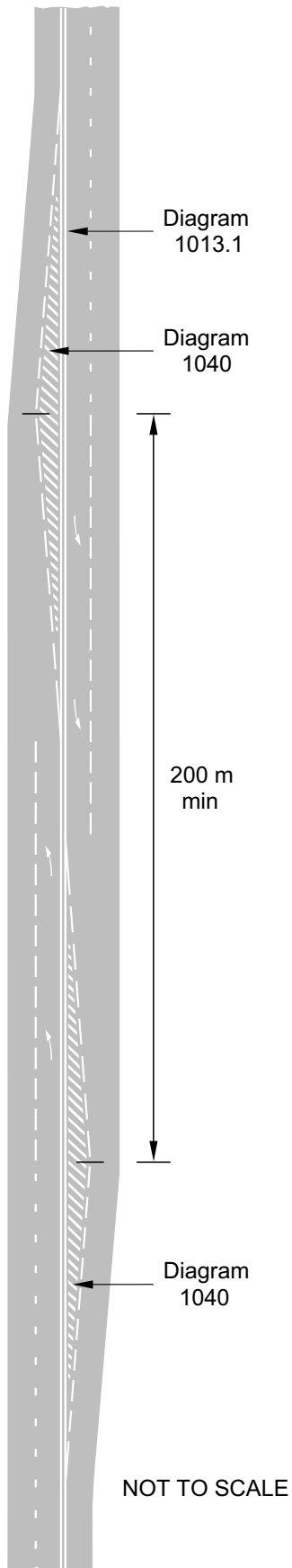

Figure 3-8 Layout of markings at a crest

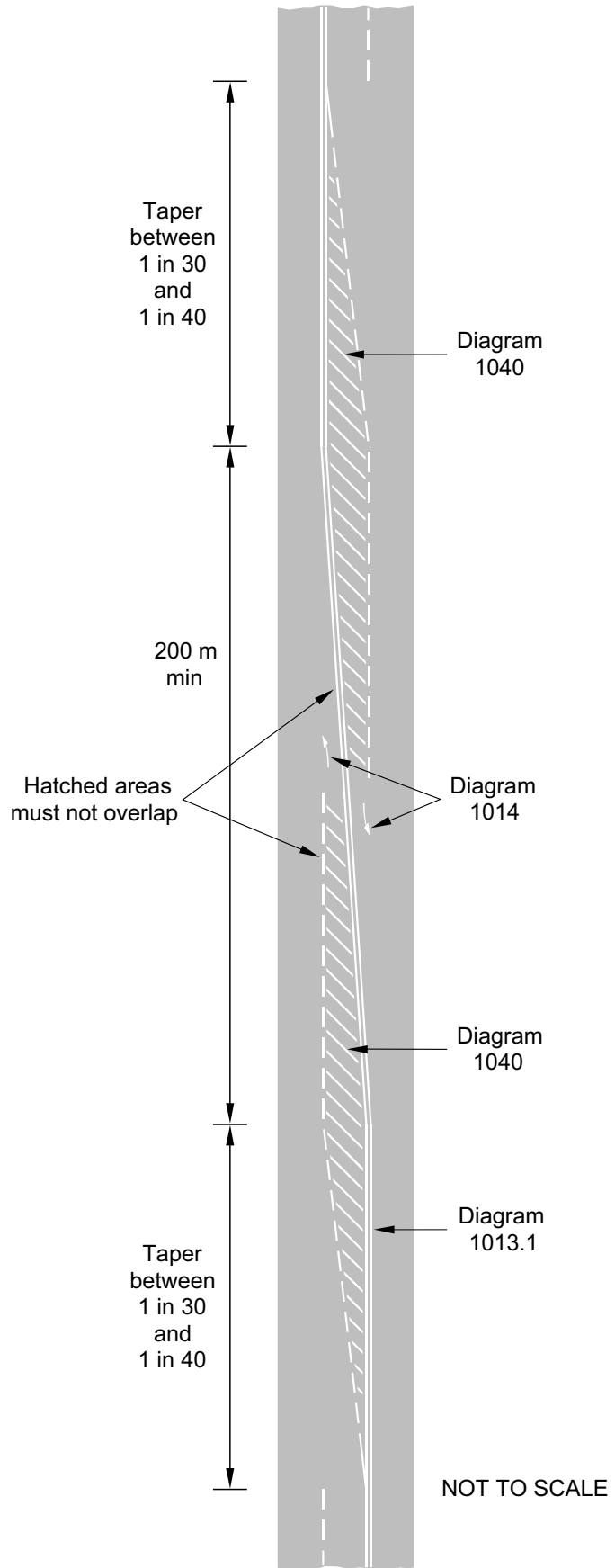

Figure 3-9 Layout of markings at a crest where carriageway width is unchanged

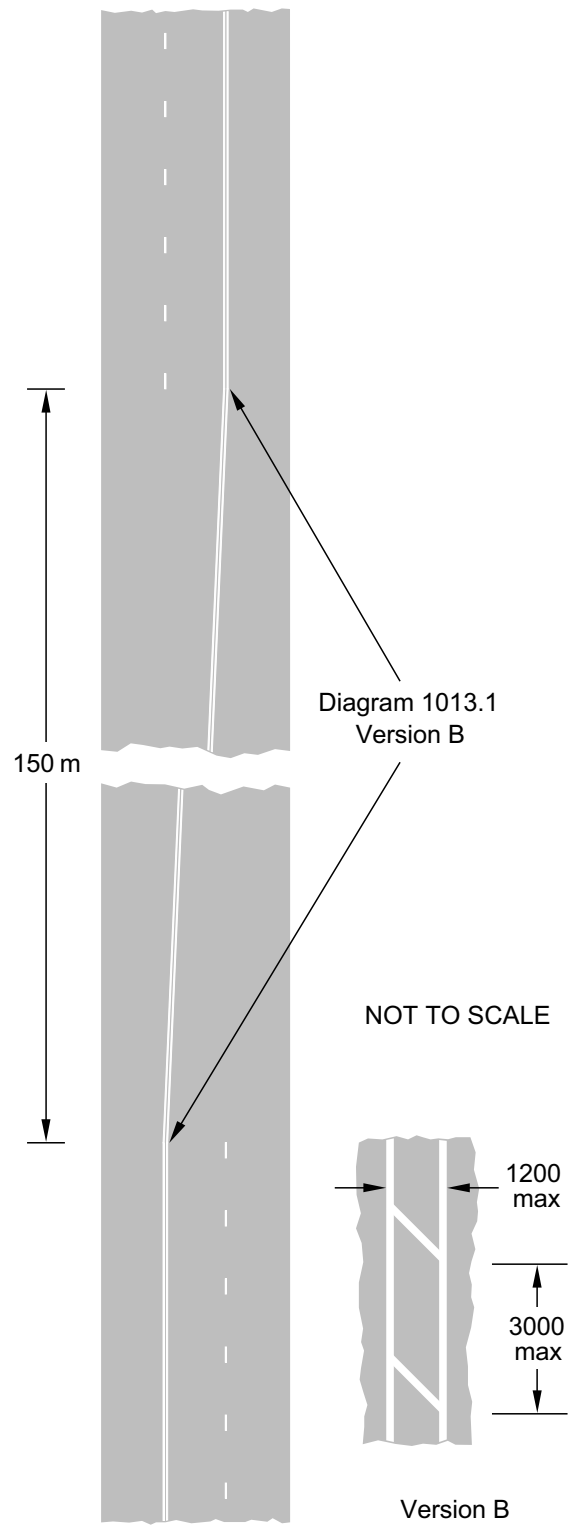

Figure 3-10 Layout of markings at sag between two climbing lanes

4.1 General

4.1.1. Retroreflective road studs are frequently used to supplement longitudinal road markings. They depend for their brightness on the light from a vehicle's headlamps being reflected back towards the source. The driver sits behind the headlamps and sees a bright reflection from the stud. They are used in addition to reflectorised lines where traffic flows are high, particularly on roads without street lighting. They remain effective in wet weather and also in areas prone to fog, when the efficiency of reflective markings is reduced. They are therefore of great value in helping drivers keep to their lane, but this benefit is lost if they are not properly maintained. Where studs are replaced, and the new stud is placed directly adjacent to an existing stud, it is important to ensure that the old stud is removed and that the road is reinstated to a good standard. Green studs in the diverge marking to diagram 1010 (S11-4-10) at grade-separated junctions (see [4.4.1](#) and [Table 2-5](#)) are especially valuable in clearly identifying the start and finish of the exit point. This is particularly important on wet roads at night, when road markings are generally much more difficult to see. Because of the heavy trafficking experienced by studs in this position, it is important to specify the most robust and high-visibility types available (classes S1 and R3 in BS EN 1463-2). The latest types of active road stud offer better visibility than retroreflective studs, and may also now be more durable, but must be of a type approved by the Secretary of State or appropriate national authority.

4.1.2. S9-8-10 and S9-8-11 require white road studs to be used in conjunction with the double white line system to diagrams 1013.1 and 1013.5 (S9-6-23 and S9-6-24 respectively). They are usually placed in a single row between the lines in diagram 1013.1, except when there is hatching between the lines (version B) where a double row of studs is likely to be appropriate (see [3.3](#)).

4.1.3. Road studs may be used with most other longitudinal white lines (see the appropriate Schedules where the markings are prescribed). They should always be used on motorways, and are recommended for use on high speed all-purpose roads, even when street lighting is provided.

4.1.4. For guidance on the use of road studs at the change from dual to single carriageway, see [2.10](#). The positioning of studs relative to edge lines is dealt with in [2.5.13](#).

4.1.5. Bi-directional road studs may be used for certain applications on single carriageway roads, including the double white lines in diagram 1013.1 (subject to the exception described in [3.3.2](#)), and should always be used in a line that separates opposing flows of traffic. They are not appropriate for marking lines bounding central hatched markings, including the double white lines in diagram 1013.5; these should make use of the uni-directional type. This is because bi-directional studs can make the hatched area appear to be another traffic lane, especially on wet roads at night, when the hatched markings may not be clearly visible. Moreover, because reflectors on the leading edge of a bi-directional stud tend to deteriorate faster than those on the trailing edge, it can also result in the studs on the far side of the hatching or taper being brighter than those on the nearer side. There is then a risk of drivers being guided onto the hatched area, which would be unlawful in the case of continuous white lines.

4.2 Type approval

4.2.1. The minimum performance requirement for retroreflective road studs is now specified in direction 7 by reference to the appropriate classes set out in parts 1 and 2 of BS EN 1463, and the former type approval process under which studs had to be approved by the Secretary of State has been superseded. Type approval will continue to be needed for studs outside the scope of the European Standard, e.g. those which incorporate a light source.

4.3 Types of road stud

4.3.1. Studs may be permanent or temporary, and use a glass or plastic reflector, or a plastic reflector with an abrasion resistant protective coating. The standard provides several different photometric performance classes, depending on the stud type. Road studs used to mark crossing places are covered in Chapter 6.

4.3.2. Studs may also be depressible or non-depressible. In the former, the stud is mounted in a base unit which is embedded into the carriageway. It is designed in such a way that a passing vehicle depresses the stud thus wiping the reflectors clean by a “squeegee” action. Non-depressible studs with rigid retroreflectors can be surface bonded or anchored using suitable adhesives, or embedded into the carriageway using a base unit. The maximum prescribed height for a depressible stud is 25 mm and for a non-depressible stud 20 mm (regulation 10).

4.4 Colour of road studs

4.4.1. Retroreflecting road studs are prescribed for use with reflectors coloured white, red, amber or green. The colours are specified by chromaticity co-ordinates in BS EN 1463-1 and are used as follows:

WHITE – to indicate a traffic lane or centre of carriageway marking.

RED – to indicate a line of studs which should not be crossed. It is used mainly to delineate the left hand edge of the running carriageway; studs are omitted at positions where traffic is permitted to cross, e.g. at a lay-by (where green studs are normally substituted). Red studs are used also in conjunction with the marking shown in diagram 1012.1 (S11-4-11) to indicate the boundary between the carriageway of a smart motorway and an actively managed hard shoulder (see [2.6.3](#)). They should never be used at the back edge of a hard shoulder. Where studs are used with chevron markings to diagram 1041 (S11-4-27) or 1042 (S9-6-22) they must be coloured red on both sides of the marking.

AMBER – to indicate a line of studs which should not be crossed. It is used to indicate the right hand edge of the running carriageway adjacent to the edge of the central reservation or to traffic cones or cylinders at road works, or the marking to diagram 1040.3 (S11-4-24). Amber studs are also used on the off side of a one-way road (including one-way slip roads and link roads).

GREEN – to indicate a length of the edge of the carriageway which may be crossed. Green studs are used with markings to diagram 1010 (S11-4-10; see [2.5.4](#) and [2.5.5](#)) at lay-bys (but not emergency refuge areas on actively managed hard shoulders on smart motorways; see [2.5.4](#)) and to mark the boundary of acceleration and deceleration lanes on the left hand side of the carriageway. They must not be used in conjunction with Stop or Give Way transverse markings, or with diagram 1009A. At lane-drop junctions (see [Figure 7-7](#)), and right-turn lanes (see [Figure 5-11](#)), green studs are used with the marking to diagram 1010 which demarcates the exit lane. Green studs may be used also within the broken lines forming part of the markings

to diagram 1025.1 (S7-4-9) to indicate the edge of the main carriageway where a bus stop clearway is located in a lay-by (see Chapter 3).

4.4.2. On dual carriageway roads, amber studs placed adjacent to the central reservation may have red reflectors on the reverse for use when contraflow working is needed for road maintenance purposes.

4.4.3. The colour of the road stud body may be:

- a) white,
- b) the same as the reflectors or retroreflecting material,
- c) a natural metallic finish, or
- d) any other neutral colour (including black).

4.4.4. In the case of studs placed temporarily at road works, the stud body must be fluorescent green / yellow. The use of temporary studs is described in Chapter 8.

4.5 Stud spacing

4.5.1. The spacing of road studs used with double white lines is dealt with in **3.3.1**. The spacing of studs used with centre lines, lane lines and warning lines is described in **Table 2-1**, **Table 2-2** and **Table 2-3**, and studs used in conjunction with continuous edge lines or with diagram 1010 in **Table 2-5** and **7.4.1**.

4.5.2. On dual carriageway roads where red, white and amber studs are used, these are normally spaced at 18 m intervals. There may be some minor advantage in offsetting the white lane line studs 9 m longitudinally relative to the red and amber studs. This does not apply where the shorter lane line module to diagram 1005 (S11-4-4) is used. Where red studs are used adjacent to chevron markings, the spacing should be closed up to 3 m centres.

4.5.3. The standard 18 m spacing, including edge lines on single carriageway roads, should be reduced to 9 m on bends with a radius of curvature less than 450 m, or on roads particularly prone to fog and mist or where there is a severe dazzle problem caused by glare from the headlamps of oncoming vehicles.

5.1 General

5.1.1. Whilst this section deals with road markings for various types of priority junction, reference should always be made to TD 42 ‘Geometric Design of Major/Minor Priority Junctions’ for actual junction layout design.

5.2 Simple junctions

5.2.1. **Figure 5-1** illustrates the layout of a simple T-junction and **Figure 5-2** shows other types of T-junction. Guidance on the use of Give Way lines (diagram 1003A; S9-6-3) can be found in Chapter 3, on warning lines (diagrams 1004 / 1004.1, S11-4-2 and S11-4-3) in 2.4 and on edge lines (diagrams 1009A and 1010; S11-4-8 and S11-4-10) in 2.5. **Table 5-1** gives details of the warning line, road studs and the minimum number of marks to be used where practicable. This number may not always be achievable on the minor road if this is narrow, but designers should provide as many as possible.

Table 5-1 Warning lines at major / minor junctions on single carriageway roads

Diagram No. (TSRGD ref)	Speed limit (mph)	Mark (m)	Gap (m)	Width (mm)	Spacing of studs if used (m)	Minimum number of marks on each approach		
						Speed limit (mph)		
						30	40	Over 40
1004 (S11-4-2)	40 or less	4	2	100 ¹	6	5	7	-
1004.1 (S11-4-3) ²	Over 40	6	3	100 ¹	9	-	-	7

NOTE 1: The width should be increased to 150 mm if the road is 10 m or more wide with no ghost island.

NOTE 2: Where the speed limit is over 40 mph, but traffic speeds are low, the smaller module to diagram 1004 might be more appropriate, particularly on the minor road (see section 2).

5.2.2. The layout of a simple crossroads is similar to that for a T-junction. An example is illustrated in **Figure 5-3**. A similar layout is used for a staggered junction where the two minor roads are not directly opposite each other.

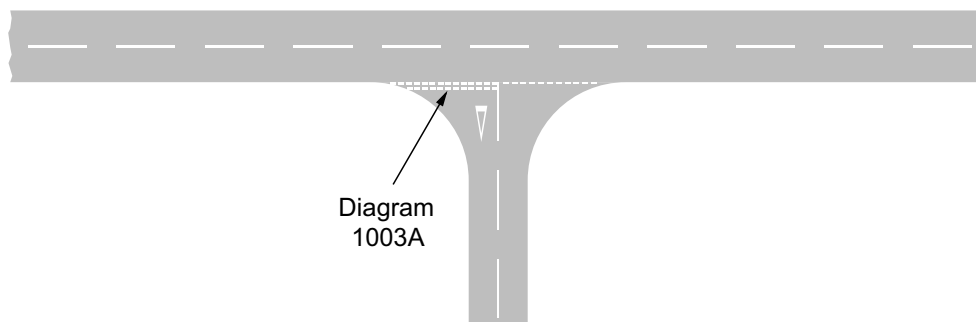

Figure 5-1 Simple T-junction

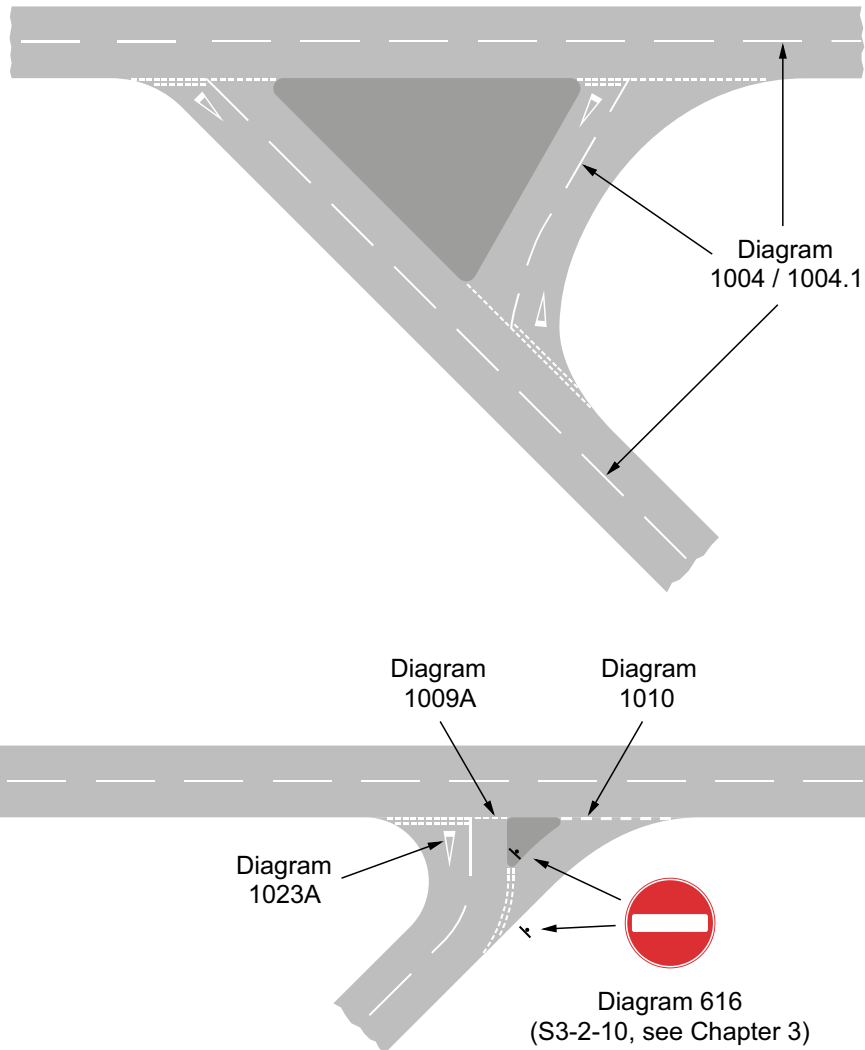

Figure 5-2 Other types of T-junction

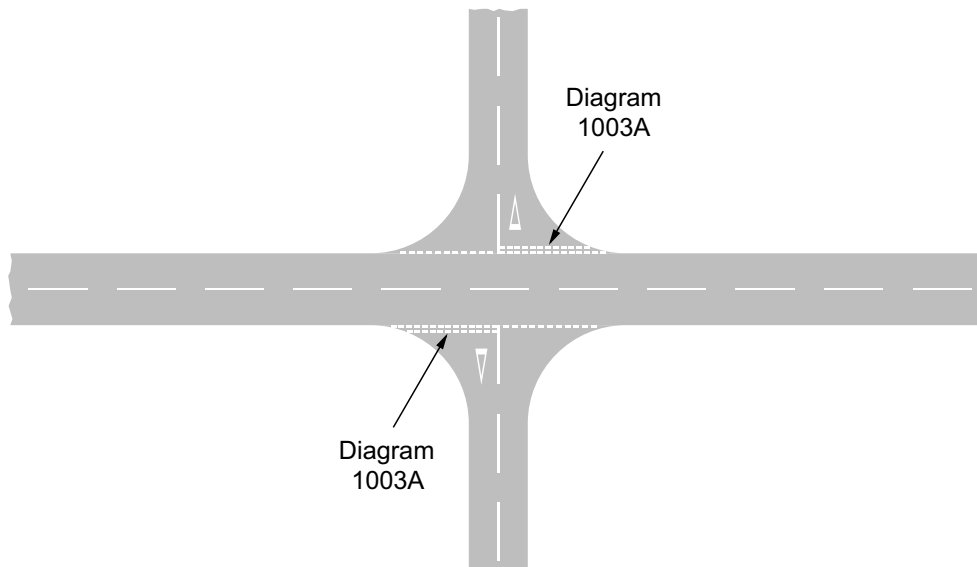

Figure 5-3 Simple crossroads

5.3 Ghost island junctions

5.3.1. Ghost island junctions are usually provided to afford right-turning vehicles some protection and assist free flow of major road through traffic. A typical layout is shown in [Figure 5-4](#). The ghost island is formed by the marking to diagram 1040 (S11-4-23) (see also [5.3.12](#) and [5.3.13](#)).

5.3.2. The use of ghost islands on unrestricted rural single carriageway roads can sometimes pose safety problems. Where overtaking opportunities on the major road are limited, the presence of a widened carriageway, albeit with hatched markings, might result in overtaking manoeuvres which conflict with right turns into and out of the minor road. Where this proves to be a problem, consideration should be given to the use of kerbed islands to prevent overtaking and to guide traffic through the junction (see [2.8](#) and [2.9](#)). Alternatively, double white lines as described in [5.3.12](#) and [5.3.13](#) may be used.

5.3.3. The through lane in each direction (c1 in [Figure 5-4](#)) should not be more than 3.65 m wide, exclusive of hard strips, nor less than 3 m. The desirable width of the turning lane c2 is 3.5 m, although this may be reduced to 3 m (but see [5.3.5](#)) or increased to 5 m (see [5.3.4](#)). A warning line (diagram 1004 or 1004.1, see [Table 5-1](#)) is used to separate the two lanes.

5.3.4. At urban junctions it can sometimes be advantageous to use a wider turning lane, not exceeding 5 m. This provides some degree of shelter in the centre of the road, helping vehicles turning right from the minor road to make the turn in two separate stages. On rural roads, with speeds above 85 kph (50 mph), or where hard strips are present, widths greater than 3.65 m are inadvisable because wide ghost islands in these situations create a sense of space which could encourage overtaking at hazardous locations. Where space is very limited, a reduced width may be unavoidable. In such cases the width of ghost islands should not be less than 2.5 m, except as described in [5.3.5](#).

5.3.5. On narrow urban roads it might not be possible to provide full width right-turning lanes. It might still be worth offsetting the main road centre line towards the minor road and using hatched markings to diagram 1040, even if the hatched width is less than 2.5 m. This can create space to help ahead traffic pass right-turning vehicles and make the junction more conspicuous. However, this technique is not appropriate where the speed limit is more than 30 mph, or the carriageway is less than 7.3 m wide. No through lane should be narrower than 3 m.

5.3.6. Central islands should normally be developed to their maximum width symmetrically about the centre line of the major road using diagram 1040 at the tapers set out in table 7/3 in TD 42 (see [5.1](#)).

5.3.7. The right-turn lane is made up of the following elements (see [Figure 5-4](#)):

- a) turning length; this allows long vehicles to position themselves correctly for the right-turn. The turning length should be 10 m, measured from the centre line of the minor road irrespective of the type of junction, design speed or gradient. Where capacity calculations indicate that there will be vehicles queuing to turn right from the major road for significant periods of time, the turning length should be increased to allow for a reservoir queuing length to accommodate them. Where this is necessary, consideration should be given to providing physical islands to afford greater protection to turning traffic,
- b) deceleration length; this component of the right-turn lane depends upon speed and gradient; its length can be found from table 7/5a in TD 42 (see [5.1](#)),
- c) through lane widths (c1) and turning lane widths (c2) (see [5.3.3](#)), and
- d) direct taper length; this is the length over which the width (d) of a right-turning lane is developed. It should be introduced by means of a direct taper which is part of the deceleration length. Its length depends upon the traffic speed and can be found from table 7/4 in TD 42 (see [5.1](#)).

NOTES

- a - see 5.3.7 (a)
- b - see 5.3.7 (b)
- c1 - see 5.3.7 (c)
- c2 - see 5.3.7 (c)
- d - see 5.3.7 (d)

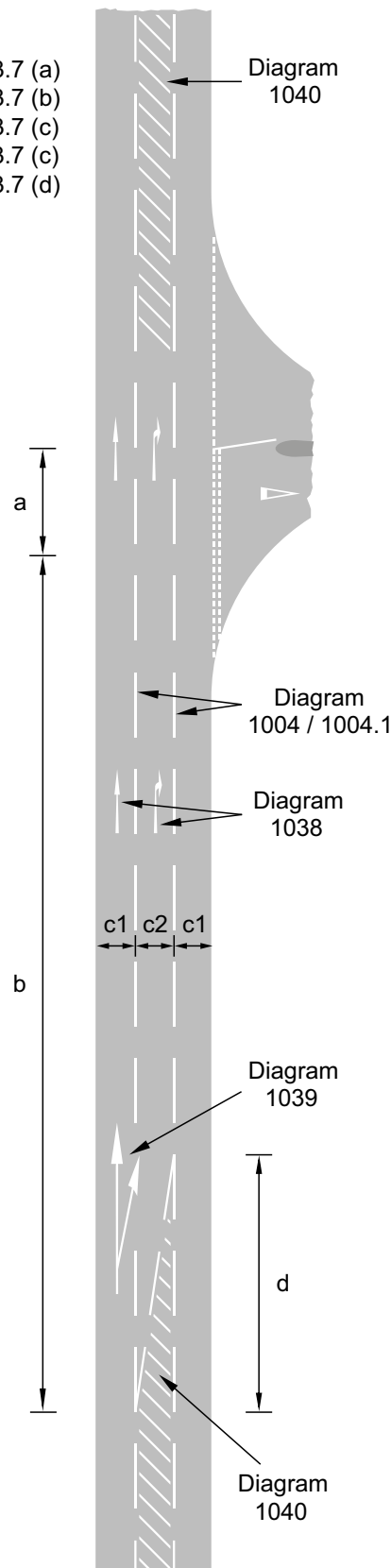

Figure 5-4 Ghost island junction

5.3.8. Where the 85th percentile speed is 40 mph or more, two deflection arrows to diagram 1014 (S11-4-14, see [Figure 9-5](#)) should be used on each approach to a ghost island marking; they may also be used where the speed is lower. A third arrow may be used if visibility is limited or if late overtaking is a problem. The spacing depends on the speed limit in the same manner as for double white lines (see [3.4.3](#)). The location of arrows in relation to the start of the taper is equivalent to the distances in [Table 3-1](#) indicating the position of arrows relative to the start of a continuous white line. The length of the arrows should also be in accordance with [Table 3-1](#).

The use of deflection arrows in association with double white lines is shown in [Figure 3-2](#) and [Figure 3-3](#).

5.3.9. Lane indication arrows are used as follows:

- a) bifurcation arrow to diagram 1039 (S11-4-22) at the start of the direct taper length, except where the right-turn lane is less than 2.5 m wide (see [2.9.3](#), [5.3.4](#) and [9.6](#) and [Figure 9-6](#)). The length of the arrow is 8 m where the warning line is to diagram 1004, and 16 m where the warning line is to diagram 1004.1. The double-headed (ahead and right) version of diagram 1038 (S11-4-20) shown in [Figure 9-1](#) should not be used in place of diagram 1039,
- b) single-headed lane arrows to diagram 1038 ([Figure 9-1](#)) should be placed as shown in [Figure 5-4](#). At least two arrows per lane should normally be provided, the last being opposite the minor road entry. However, it might not be practicable to provide two arrows where the right-turn lane is short, particularly where there is a left / right stagger as shown in [Figure 5-6](#). A right-turn arrow should not be used in the ahead lane, as traffic does not turn from that lane. The 4 m arrow should be used where the warning line is to diagram 1004 and the 6 m arrow where the warning line is to diagram 1004.1.

5.3.10. Where a ghost island staggered junction is provided, a right / left stagger as shown in [Figure 5-5](#) is preferable to a left / right stagger (see para 2.30 in TD 42). This comprises two T-junction layouts ([Figure 5-4](#)) placed one after the other. The minimum stagger distance, as measured along the major road between the centre lines of the two minor roads, should be 50 m (see para 7.64 in TD 42).

5.3.11. At left / right staggered junctions (see [Figure 5-6](#)), the deceleration lengths overlap over the direct taper length for each right-turn lane. The width of the ghost island should not be increased to allow the two right-turn lanes to be placed side by side. The line dividing the two direct taper lengths should be to diagram 1004 or 1004.1 as appropriate (i.e. the same module as the longitudinal lines).

5.3.12. To discourage overtaking on the immediate approach to a right-turn lane, continuous double white lines may be provided as shown in [Figure 5-7](#) using diagram 1013.1 (S9-6-23) and the permitted variant of diagram 1040 (S11-4-23), even where the usual visibility requirements are not met (but see [3.1.7](#)). The maximum width of the former marking is 1200 mm. The lines must not be splayed over a greater width. Unless the visibility criteria are satisfied, the lines should not be extended beyond the immediate area of the junction. Coloured surfacing may be used under the hatched marking to improve conspicuity and discourage encroachment. Although the Regulations provide an exemption (S9-7-9(5)) permitting vehicles to cross the continuous line to enter any other road or private access, the line in this case is replaced by a warning line opposite the entry into the minor road as shown in [Figure 5-7](#). Deflection arrows to diagram 1014 are required at the start of the double white line, but not where the marking recommences on either side of the junction (see [3.4.4](#)).

5.3.13. A right-turn lane on a road with a climbing lane should be marked as shown in [Figure 5-8](#) and [Figure 5-9](#) for uphill and downhill directions respectively. The continuous lines are placed on the side of the hatching that maximises protection for vehicles using the right-turn lane, except that where such vehicles are travelling uphill, the continuous lines are on the side that discourages downhill overtaking.

5.3.14. Although ghost island crossroads are not recommended (see para 2.29 in TD 42), it might not always be possible to provide a staggered junction where dedicated right-turn lanes are desirable. [Figure 5-10](#) shows how a ghost island crossroads should be marked. As there is potential conflict between vehicles turning right from both directions at the same time,

consideration should be given to the provision of kerbed islands within the hatched areas (see 2.8 and 2.9). This would help to reduce the speed of vehicles by preventing direct entry into the right-turn lanes across the hatched markings. Also, the use of coloured surfacing under the hatched markings should be considered. The diagonal line separating the opposing right-turn lanes should be well maintained. Where diagram 1004 is used for the longitudinal lines, it might be appropriate to use the marking to diagram 1004.1 for the diagonal line as this would provide a continuous line across the whole width of the right-turn lanes.

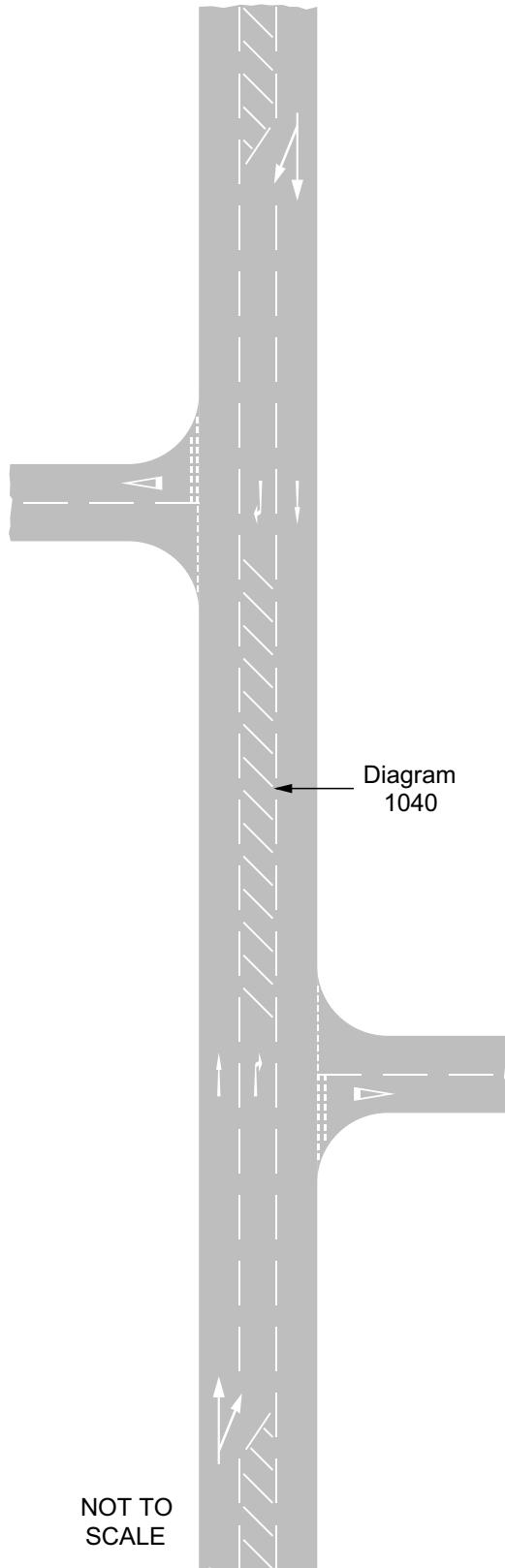

Figure 5-5 Right / left staggered ghost island junction

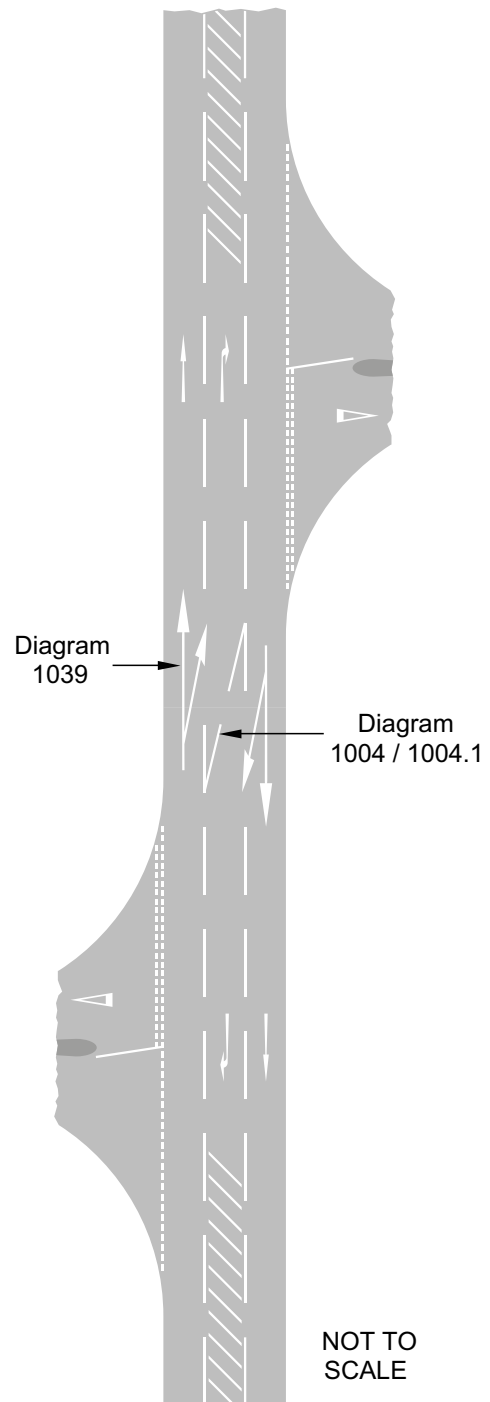

Figure 5-6 Left / right staggered ghost island junction

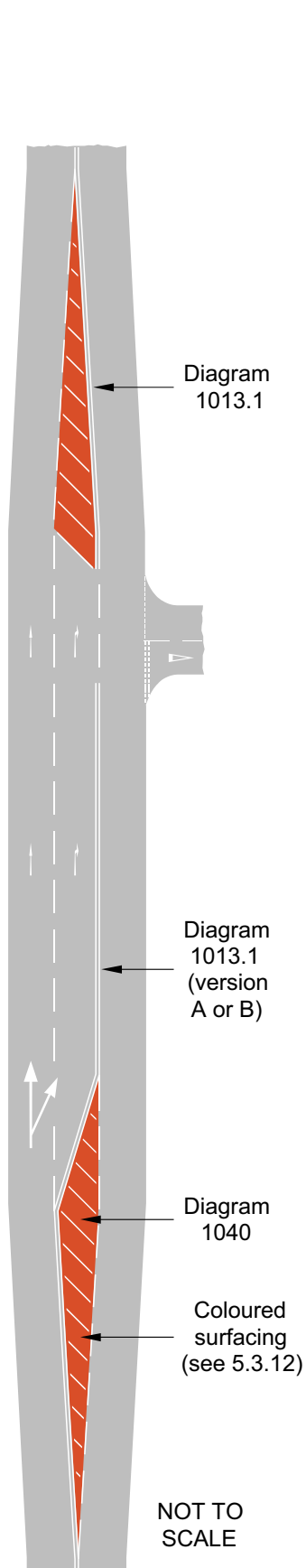

Figure 5-7 Use of double white lines to discourage

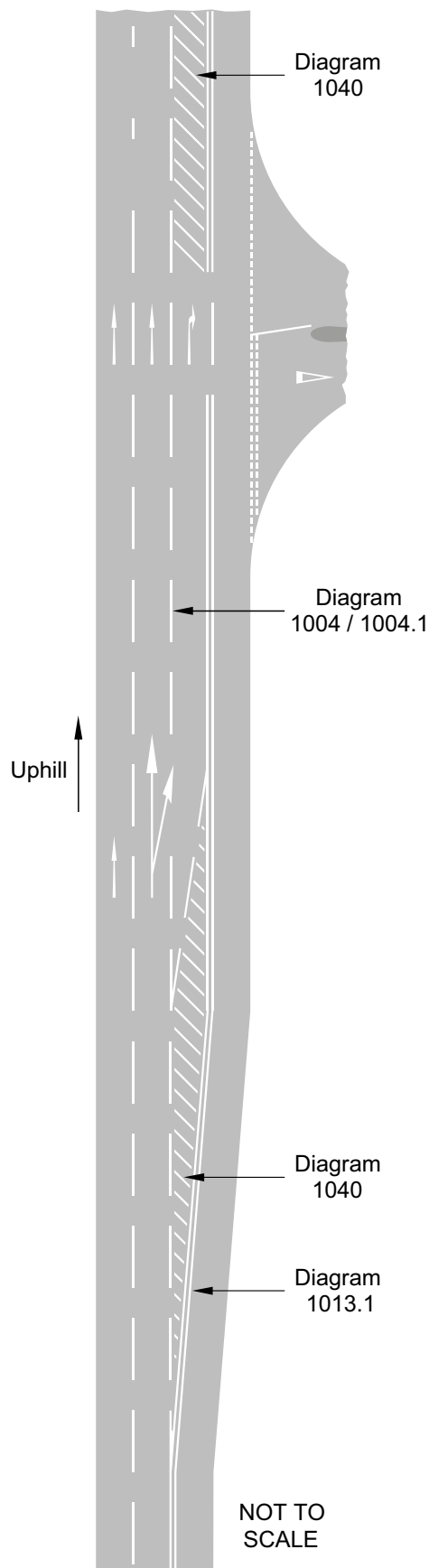

Figure 5-8 Uphill approach to right-turn lane

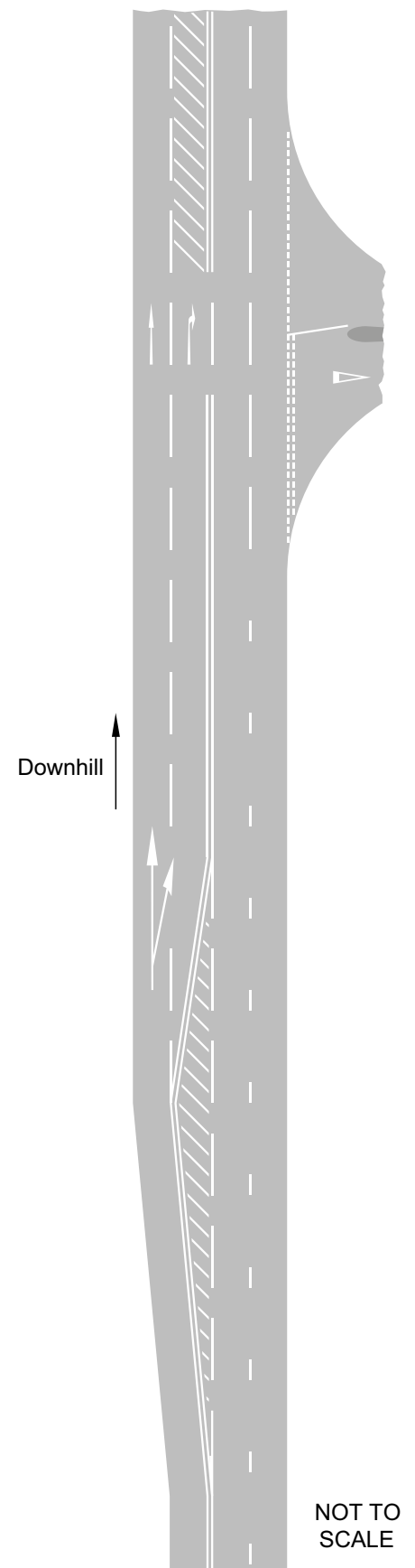

Figure 5-9 Downhill approach to a right turn

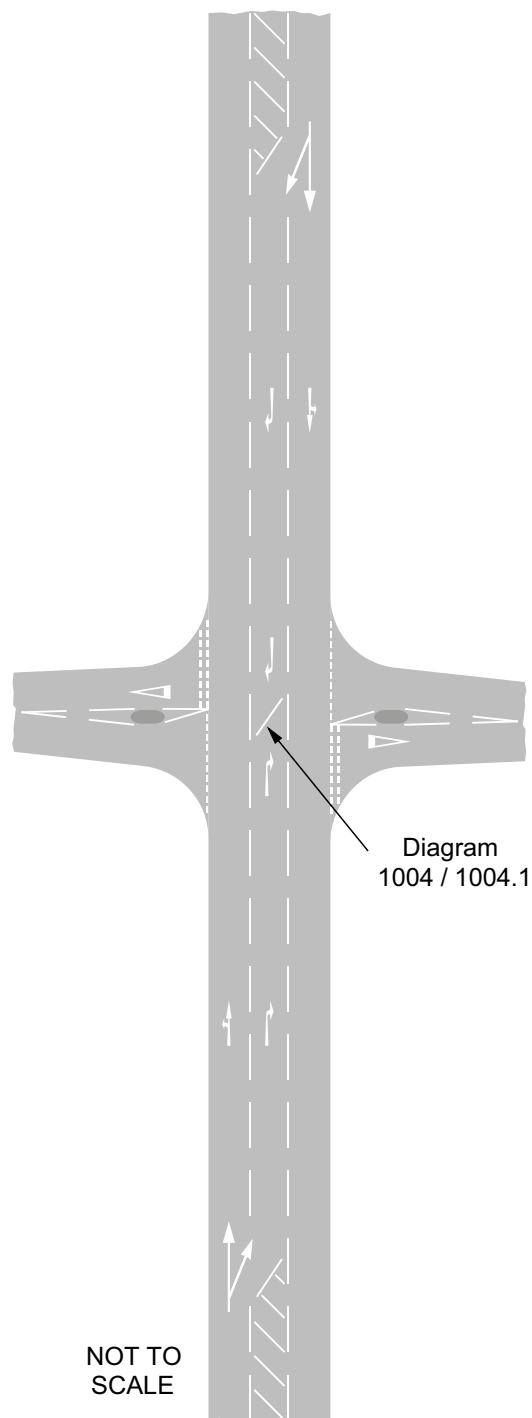

Figure 5-10 Crossroads with ghost islands

5.4 Dual carriageway junctions

5.4.1. The standard layout for a T-junction on a dual carriageway road is shown in **Figure 5-11**. This type of junction is not suitable where the main carriageway has more than two lanes (see para 2.26 in TD 42). The through lanes should maintain their width, and be separated from the right-turn lane by a line to diagram 1010 (S11-4-10), with a width of 100 mm for a speed limit of 40 mph or less, 150 mm for 50 or 60 mph and 200 mm for 70 mph (see **Table 2-5**).

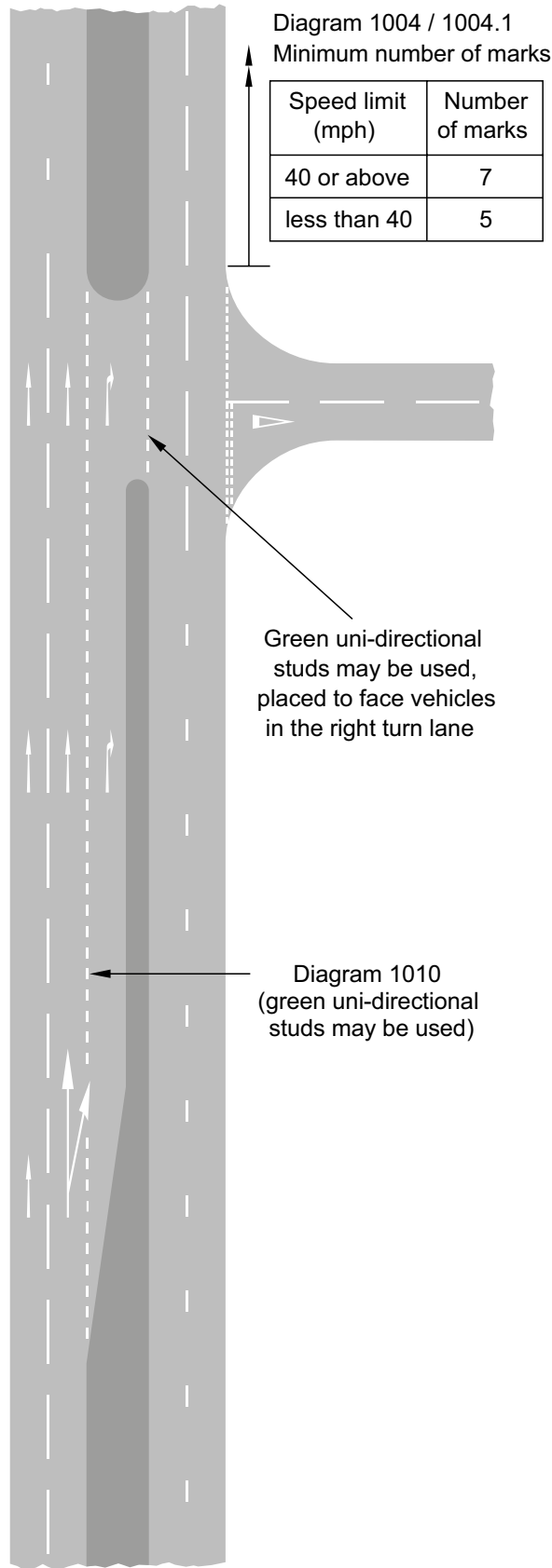

Figure 5-11 Dual carriageway junction

5.4.2. The lane line through a dual carriageway road junction should be formed of a warning line (to diagram 1004 or 1004.1 as appropriate; see **Table 5-1** in each carriageway as indicated in **Figure 5-11**).

5.4.3. Where the national speed limit of 70 mph applies, the arrows to diagram 1038 and 1039 should be 9 m and 32 m in length respectively. For other speed limits the arrow lengths are related to the module used for the warning lines (diagram 1004 or 1004.1) as set out in **5.3.9**.

5.4.4. For guidance on determining the appropriate length of right-turn lanes see [5.3.7](#). For details of the markings used at grade separated junctions see section [7](#).

5.4.5. Where a right / left staggered junction is provided on a dual carriageway, it comprises two junctions to the layout shown in [Figure 5-11](#) separated by a length of central reservation (see figure 8/2 in TD 42). Where a left / right staggered junction is provided, unlike a ghost island junction (see [5.3.11](#)), the two right-turn lanes are placed side by side, separated by a narrow central reservation (see figure 8/3 in TD 42).

5.5 Single lane dualling

5.5.1. At single lane dual carriageway junctions (see [Figure 5-12](#)), the through lane in each direction should be 4.0 m wide, exclusive of hard strips which will normally be 1.0 m wide. The arrows to diagrams 1038 and 1039 should be 6 m and 16 m in length respectively when the national speed limit applies.

5.5.2. Where there is likely to be driver confusion over priority within the central reservation opening, markings may be provide as shown in [Figure 5-12](#). This should help to reduce uncertainty and discourage parallel queuing of cars in this area.

5.5.3. Where a staggered junction is provided, the principles are similar to those for a dual carriageway junction (see [5.4.5](#)).

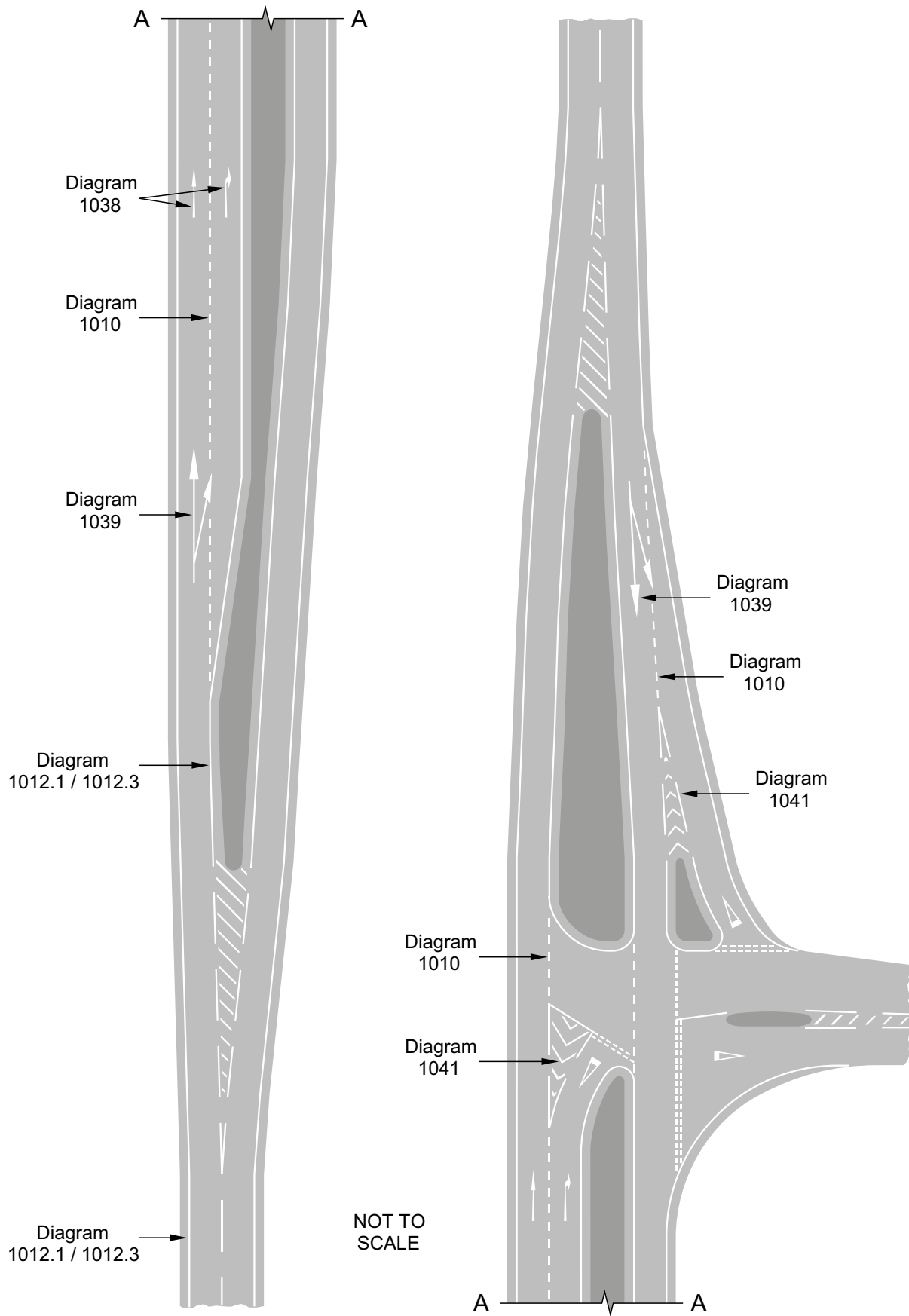

Figure 5-12 Single lane dualling

6.1 General

6.1.1. The general rule governing the behaviour of traffic at roundabouts is that drivers should give way to any traffic on their immediate right unless road markings indicate otherwise. This is implemented by the provision of an advisory Give Way line (see [6.2.2](#) and [6.3.6](#)) across the entry arm of a roundabout.

6.1.2. At all roundabouts (except those controlled by traffic signals for 24 hours per day, see [6.5](#)) the appropriate prescribed Give Way line should be laid at each entry. This should connect the deflection island (physical or ghost island), central reservation or, where no central traffic island is provided, the central warning line on the approach road (see [6.1.3](#)) to the nearside kerb, approximately following the line of the inscribed circle. This allows vehicles in the nearside lane to be positioned ahead of those in the off side lane, improving visibility to the right. A typical layout for a conventional roundabout is shown in [Figure 6-1](#).

6.1.3. Centre lines and lane lines (where provided) on the approach to roundabouts should be replaced by warning lines (see [2.3.3](#), [2.4.12](#), [2.4.13](#) and [Table 2-3](#)). Where required for capacity reasons at a normal roundabout, the number of lanes on the approach to the Give Way line should be increased. This will ensure that maximum use is made of gaps in the circulating traffic. However, care should be taken to avoid releasing too much traffic for the space available to receive it. Where the carriageway is widened on the approach to a roundabout and extra lanes provided, drivers should be made aware of this by marking the lanes as early as possible. However, no lane should be less than 2 m wide at the start of the taper, or less than 3 m wide at the Give Way line (see [Figure 6-1](#)).

6.1.4. It is important to provide adequate vehicular deflection through a roundabout to limit vehicle speeds. TD 16 'Geometric Design of Roundabouts' shows how to determine the entry path radius to provide the appropriate deflection.

6.1.5. The types of roundabout described in this section are as follows:

- a) conventional roundabout (see [6.2](#) and TD 16/07 which classifies roundabouts as "normal", "compact" and "grade separated")
- b) mini-roundabout (see [6.3](#) and TD 54 'The Design of Mini-roundabouts')
- c) double roundabout (see [6.4](#) and TD 16 and, for mini-roundabouts, TD 54)
- d) signalised roundabout (see [6.5](#) and TD 50 'The Geometric Layout of Signal-Controlled Junctions and Signalised Roundabouts')

6.1.6. Other features used include lane markings in the circulating area (see [6.6](#)), lane destination markings and arrows (see [6.7](#)) and segregated left-turn lanes (see [6.8](#)).

6.2 Conventional roundabouts

6.2.1. These have a one-way circulatory carriageway around a kerbed central island, often with flared approaches to allow multiple vehicle entry (see [Figure 6-1](#)). A compact roundabout has a single lane approach and might be appropriate in urban areas where there are physical constraints (see TD 16/07). Physical splitter islands are used to guide traffic and ensure adequate deflection.

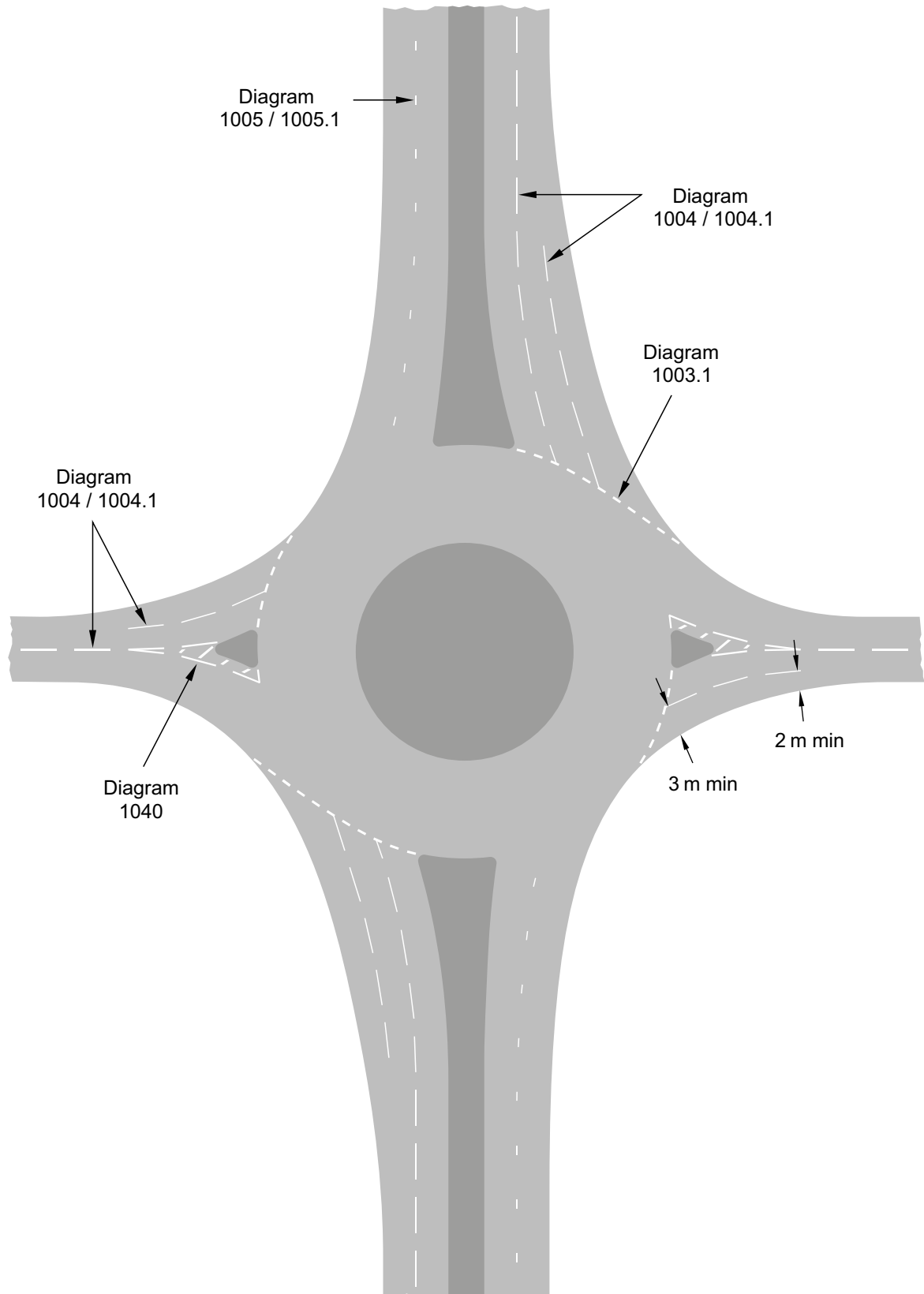

Figure 6-1 Conventional roundabout

6.2.2. The Give Way marking to diagram 1003.1 (S11-4-1) is used. The width of the line should be 300 mm where the warning line on the approach to the roundabout is to diagram 1004.1 (S11-4-3) or where any hatched marking has a boundary line comprising a 6 m mark and a 3 m gap (see 2.7.1). In other circumstances, the width of the line should normally be 200 mm. The marking to diagram 1003.3 should be adopted when the roundabout has a small central island, up to approximately 4 m in diameter.

6.2.3. The number of lanes on the approach should be increased only for capacity reasons and where there is room to do so. Extra lanes will increase capacity only if there is sufficient circulating width in the roundabout to accept the traffic and sufficient exit lanes to clear it. Normally it will be the nearside lane that widens to provide the extra lane, but widening on the off side provides an extra lane for right-turning traffic.

6.3 Mini-roundabouts

6.3.1. Mini-roundabouts can be very effective in improving existing urban junctions which experience safety and side road delay problems, and can often be installed with minimal alterations to kerbs etc. They have a one-way circulatory carriageway around a flush or slightly raised central disc, with or without flared approaches. Three arrows around the central disc indicate the clockwise direction of circulation. The marking (diagram 1003.4; S9-6-5) carries no street furniture, and may be overrun by large vehicles if necessary (S9-7-5). Mini-roundabouts are not used at new junctions or on dual carriageway roads (see TD 54).

6.3.2. The layout should be designed so that drivers are made aware in good time that they are approaching a roundabout. Mini-roundabouts should be used only when all approaches are subject to a speed limit of 30 mph or less (see TD 54). Their use on roads with a higher speed limit is not recommended as it is seldom possible to achieve adequate deflection and the marking may not be sufficiently conspicuous at higher speeds.

6.3.3. Two size ranges are prescribed for the mini-roundabout marking (see [Figure 6-2](#)); the choice will depend on the road space available and the need for conspicuity. The larger range should be used to provide deflection and deter straight through movement. The smaller range may be adequate at more constricted sites where the marking would otherwise occupy too large a part of the carriageway space and might be confusing, or where frequent over-running would result in excessive maintenance costs. It should be noted that the diameter of the central disc is not related to the overall size of the marking and may be varied independently of the diameter of circulatory arrow marking comprising the three arrows.

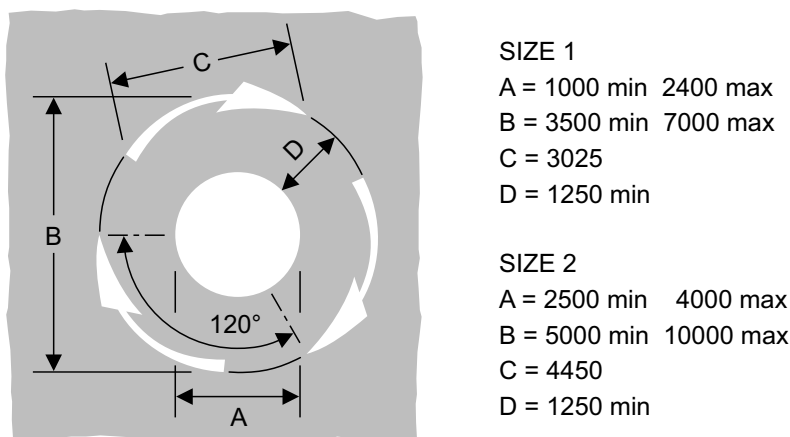

Figure 6-2 Diagram 1003.4 (S9-6-5) Mini-roundabouts (Alternative sizes)

6.3.4. In no circumstances may annular rings be added around the central disc. If a more conspicuous central marking is necessary, a larger disc, up to a maximum of 4 m should be used. If the junction area is very large, the diameter of the circulatory arrow marking should be increased to a maximum of 10 m, with the length of the arrows correspondingly increased to 4.45 m. Full design details for the individual arrows can be found on working drawing P 1003.4 (see [1.7.4](#)). Conspicuity may be further enhanced by replacing the normal central warning line on the approach with a hatched marking to diagram 1040 (S11-4-23).

6.3.5. The central disc of the mini-roundabout marking may be domed up to a maximum height of 125 mm (S9-8-4), but must not exceed 6 mm at the perimeter. This will increase the conspicuity of the roundabout, particularly in wet weather. However, research evidence indicates that accident rates at domed roundabouts are slightly higher than at flush roundabouts, although the accident severity is less. The dome may be formed in bituminous or other suitable material, but the surface must be white and be retroreflective (S9-8-13).

6.3.6. The standard Give Way marking used at mini-roundabouts is diagram 1003.3 (S9-6-6). When used at mini-roundabouts, it must be accompanied by the upright sign to diagram 611.1 (S9-2-6; see Chapter 3) and may be accompanied by the triangular road marking to diagram 1023A (S9-6-4). In certain circumstances the Give Way marking to diagram 1003A (S9-6-3) may be used (see 6.3.8 and Figure 6-3). Diagram 611.1 will normally be sited about 1.5 m in advance of the Give Way marking. This might have to be increased if the sign would not otherwise be clearly visible, but to no more than 12 m.

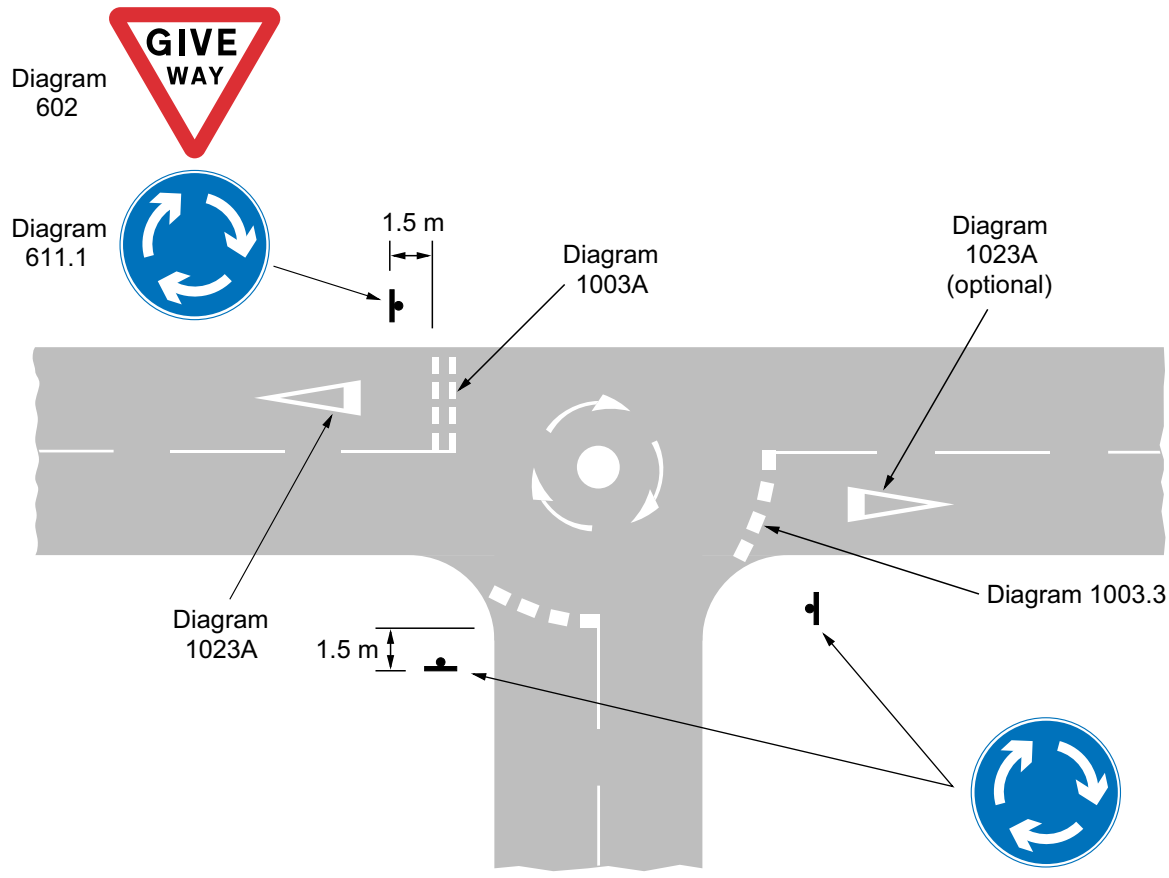

Figure 6-3 Options for marking approaches to mini-roundabouts

6.3.7. Road markings or small traffic islands should be placed so as to ensure some vehicle deflection on the approaches; hatched markings to diagram 1040 can often help. Physical islands should be kept free of all furniture except the “keep left” bollards and other essential signs. Where an existing junction is being converted to a mini-roundabout, it may not be practicable to achieve the ideal amount of deflection. However, this may be acceptable if approach speeds are low.

6.3.8. Where suitable deflection cannot be achieved, traffic entering the roundabout might, because of its approach speed, disregard the standard advisory Give Way line (diagram 1003.3). In such cases, the mandatory GIVE WAY sign to diagram 602 (S9-2-2) may be mounted on the same post and above the sign to diagram 611.1 (see Chapter 3 and 2.4.9). The GIVE WAY sign should not be used where it could confuse drivers into giving way to traffic from the left as well as from the right, e.g. on the stem of a T-junction or on any arm of a four-way

junction. When diagram 602 is used, it must be accompanied by diagram 1023A and by the Give Way marking to diagram 1003A (see [Figure 6-3](#)).

6.3.9. Additional guidance on mini-roundabouts is available in the Department for Transport's publication 'Mini-roundabouts – Good Practice Guidance' which is available at:

www.gov.uk/government/publications/mini-roundabouts

6.4 Double roundabouts

6.4.1. These junctions have two conventional or mini-roundabouts either contiguous (see [Figure 6-4](#)) or connected by a central link road or kerbed island (see [Figure 6-5](#)). Conventional and mini-roundabouts should not be mixed at the same junction.

6.4.2. Double roundabouts may offer an effective means of dealing with turning movements at asymmetrical junctions, those with a stagger, or junctions with high opposing right-turn flows.

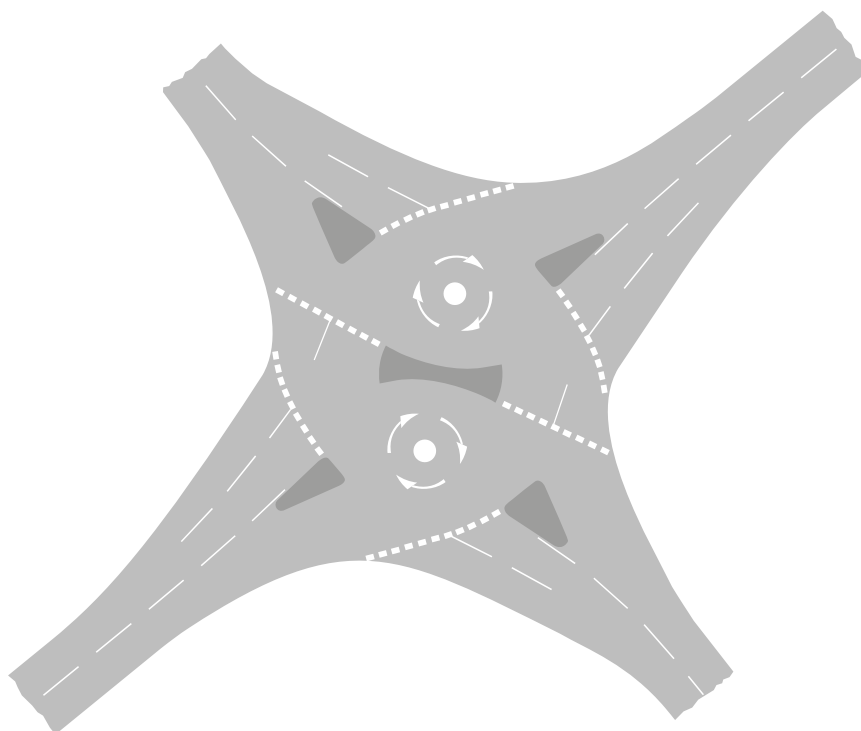

Figure 6-4 Contiguous double mini-roundabout

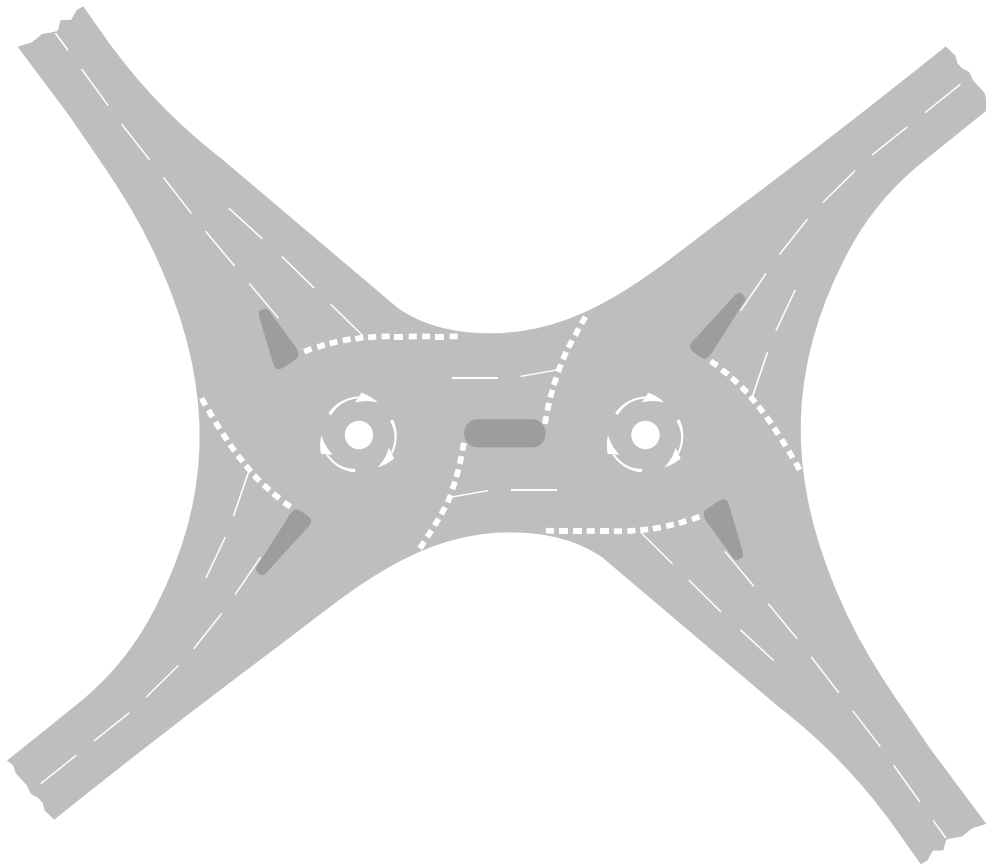

Figure 6-5 Double mini-roundabouts with short central link

6.5 Signalised roundabouts

6.5.1. These have traffic signals in use on one or more of the approach arms for part or all of the day. Further guidance on the use of signals at roundabouts can be found in TD 50 and in Local Transport Note (LTN) 1/09 'Signal Controlled Roundabouts'.

6.5.2. Where signals are used, traffic signal stop lines should be laid on the main circulating carriageway, approximately at right angles to the carriageway edge. The approach road should be marked as follows:

- a) full-time signals – Stop line to diagram 1001 (S14-2-46), or
- b) part-time signals – Stop line to diagram 1001 and Give Way line to diagram 1003.1 (S11-4-1). If the entry angle is such that the Stop and Give Way lines are coincident, or nearly so, the former may be omitted, but only with the issue of a special direction by the Secretary of State to the effect that Schedule 14 General Direction 2 does not apply (see [1.2.1](#)).

6.6 Lane markings in the circulating area

6.6.1. Road markings may be used to channelise traffic and indicate which lane to use at and through roundabouts. Lane markings can increase capacity by improving both the use of road space on the roundabout and the level of gap acceptance of drivers joining it. They can also reduce the following types of accidents on roundabouts:

- a) side-to-side collisions on the circulating carriageway,
- b) drivers being forced onto the central island, and
- c) collisions between entering and circulating vehicles.

6.6.2. Markings should be designed to create flowing paths around the junction for all movements, avoiding sharp turns and providing a smooth alignment between entry and exit markings. Lane markings are always provided when the roundabout is under signal control, with the route through the junction designed to avoid lane changing on the immediate approach to a Stop line.

6.6.3. There are four basic configurations of road markings which may be used on the circulatory carriageway, making use of diagrams 1004 / 1004.1 (S11-4-2 and S11-4-3) and 1040.4 (S11-4-25). These are summarised below and are illustrated in TA 78:

- a) concentric markings (see [6.6.4](#)),
- b) partial concentric markings (see [6.6.5](#)),
- c) concentric-spiral markings (see [6.6.6](#)), and
- d) spiral markings (see [6.6.7](#)).

6.6.4. Concentric markings trace a complete path around the circulatory carriageway encouraging drivers to enter and circulate in two or more adjacent lanes.

6.6.5. Partial concentric markings differ from concentric markings in that their continuity around the circulatory carriageway is interrupted. They can assist on wide circulatory carriageways by presenting drivers with clearly defined lanes within which to pass around the junction, and reduce the likelihood of drivers in the off side entry lane being forced towards the central island.

6.6.6. Concentric-spiral markings are similar to concentric markings except that the outermost circulating lane or lanes guide traffic to the next exit by means of a lane-drop. This is effected by running the circulatory markings directly into the existing road markings on that exit. They help to reduce conflicts between vehicles at the exits where more than one exit lane is provided, and can be used with any number of circulating lanes.

6.6.7. Spiral markings are more appropriate on larger roundabouts and involve a series of lane-gains, which may be preceded by the marking to diagram 1040.4 adjacent to the central island, and lane-drops around the circulatory carriageway so that drivers enter in the lane appropriate for their desired exit and follow that lane around the roundabout to be led off at the exit. These markings may be supplemented by lane destinations or route numbers to diagram 1035 (S11-4-19) with or without arrows (see [6.7](#) and section [9](#)). Spiral-type markings might be used on a signalised roundabout to avoid lane changing on the approach to a Stop line.

6.6.8. If a roundabout has multiple lanes and traffic needs to cross them in order to position itself correctly, it may be useful to use markings to diagram 1005 (S11-4-4) placed at an oblique angle to those in the running lanes (see [Figure 6-6](#)).

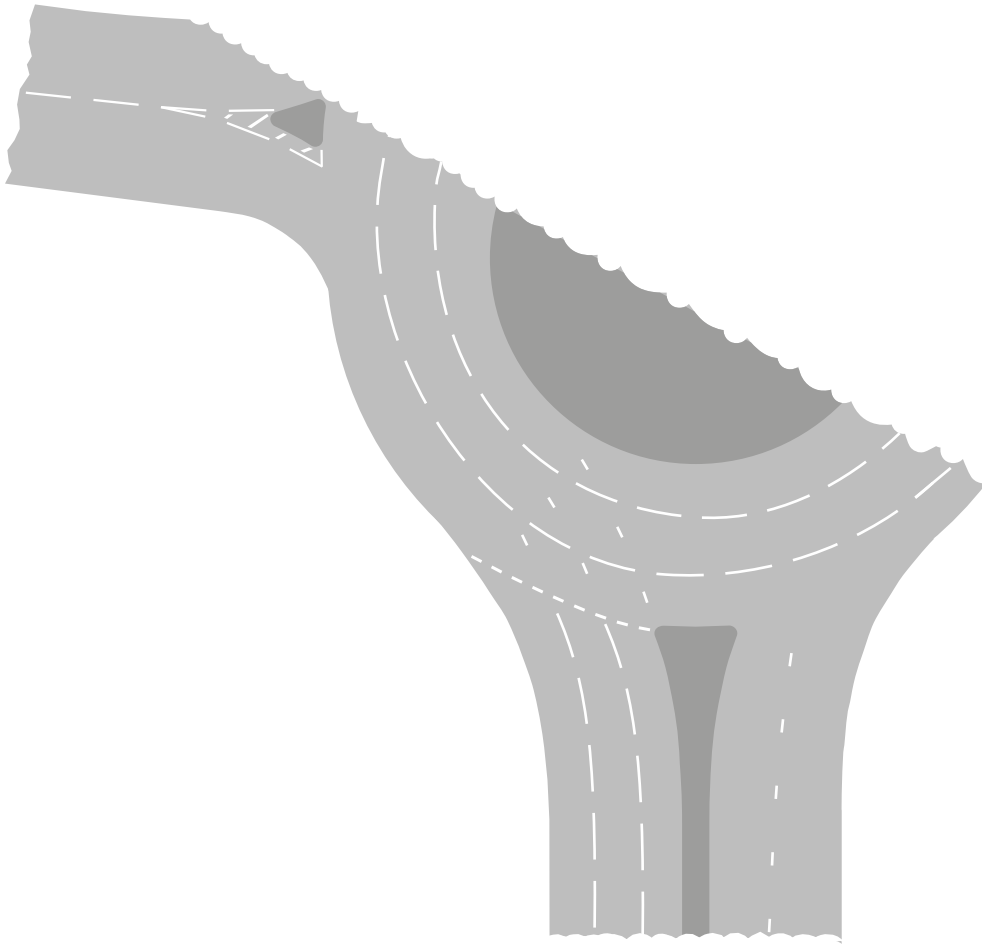

Figure 6-6 Roundabout with lane guidance (“kick”) markings to diagram 1005 (S11-4-4)

6.7 Lane destination markings and arrows

6.7.1. Lane destination markings and arrows to diagrams 1035 and 1038 (S11-4-19 and S11-4-20 respectively, see 9.1 and 9.2) may be used on the approach to and in the circulating areas of multiple lane signalised roundabouts, and those with circulatory markings (see 6.6). This may increase the capacity of a roundabout or make it safer, but will be successful only if drivers are given proper advance warning either by road markings or upright signs. The latter must be consistent with the markings. Lane destination markings and arrows might be justified for other roundabouts where turning flows are consistently heavy throughout the day. Careful judgement is needed to ensure that such markings are not used inappropriately, as the reduction in flexibility may adversely affect the capacity of the roundabout. Special care must also be taken when changing the markings at a roundabout from one type to another, because local behaviour can be ingrained and sometimes temporary signs are not sufficient to warn of a change.

6.7.2. It is possible that the use of a right-turn arrow on the approach to a roundabout might encourage some drivers, particularly those from overseas, to turn the wrong way into the circulatory carriageway. However, in most situations the clockwise direction of circulation should be apparent. Where the right-hand lane is dedicated to right-turning traffic, a right-turn arrow should not present any difficulties and will ensure appropriate use of the lane. There will be some situations, particularly where the roundabout has spiral markings (see 6.6.7) or is controlled by traffic signals, where it is likely to be more appropriate to use ahead arrows with destinations for all approach lanes.

6.7.3. Lane arrows and destinations will usually be repeated on roundabout circulatory carriageways when they have been used on the entries. They help drivers to identify the correct

lane as early as possible and are particularly important if the lane is dedicated to a specific exit. They should also be used on the main carriageway of gyratory systems, i.e. large roundabouts formed of a series of one-way roads. Left-turn arrows should not be used on the circulatory area immediately in advance of a point where a slip road enters from the left. This can confuse some drivers into turning left prematurely and travelling the wrong way along a dual carriageway. Where space permits, an ahead arrow may be used at this point, followed by a left-turn arrow beyond the entering road. Lane destinations to diagram 1035 may be used without arrows (S11-5-45), particularly where dedicated lanes lead directly to the exits from a roundabout. This might be appropriate where there is insufficient space to provide both arrows and destinations.

6.8 Segregated left-turn lanes

6.8.1. Segregated left-turn lanes reduce conflict between vehicles turning left at the first exit and those already circulating (see [Figure 6-7](#)). They can also reduce traffic delays and improve journey times. The segregation may be effected by road markings to diagram 1041 (S11-4-27) or 1042 (S9-6-22), or by a physical island in conjunction with one of those markings. Where a physical island is not provided, the marking to diagram 1042 is likely to be more appropriate than the marking to diagram 1041. The former is the more emphatic marking and it is an offence to cross it except in an emergency. Should the marking to diagram 1041 be used, drivers might be tempted to change lanes prematurely.

6.8.2. Left-turning traffic is channelled into the left-hand lane using lane arrows and road markings, supplemented by upright dedicated lane advance direction signs. Left-turning vehicles proceed without having to give way to others circulating on the roundabout. Segregation by road markings is more common but may be less effective because it is liable to abuse (see [6.8.1](#)). Segregation by a physical island should be used for signalised roundabouts. Further guidance may be found in TD 51 'Segregated Left Turn Lanes and Subsidiary Deflection Islands at Roundabouts'.

6.8.3. If left-turning traffic comprises predominantly light vehicles and there is a high proportion of cyclists or heavy goods vehicles leaving the roundabout, differential speeds in adjacent lanes at the end of the segregated lane could cause problems, particularly if there is an uphill gradient. This might be especially hazardous for cyclists.

6.8.4. [Figure 6-7](#) shows the entry and exit to and from the segregated lane as a lane-drop and lane-gain respectively. However, the entry may be a lane diverge and the exit a lane merge, incorporating the marking to diagram 1010 (S11-4-10) (see also TD 51).

6.8.5. The use of these lanes in urban areas where pedestrians might cross should be considered carefully. Pedestrians should never be expected to cross left-turn lanes segregated only by road markings. If pedestrians are likely to be present, they should be guided to an appropriate crossing point. If this is not possible, segregation should be effected by a physical island of sufficient width to accommodate the peak number of pedestrians.

6.8.6. Segregated left-turn lanes may encourage higher speed; any desirable speed reduction measures should be applied before entry to the lane and not within it. Where the proportion of large goods vehicles is high, the lane should be designed so that its width is sufficient to accommodate the swept paths of larger vehicles, especially where physical segregation is provided. Where few such vehicles are expected, the lane may be reduced to 3.5 m in width, or exceptionally to an absolute minimum of 3.3 m. Where road markings to diagram 1041 or 1042 are used to create the lane segregation, the overall width of the marking should normally be at least 1 m. Where reflecting road studs are used, these must be red (see [4.4.1](#)).

6.8.7. When segregation is achieved using road markings alone, no special allowance needs to be made for broken-down vehicles, as other traffic will not be prevented from passing (vehicles will be allowed to enter the hatched area of diagram 1042 in this case). However, whether segregation is provided by road markings or a physical island, the design should not prevent vehicles from making a left turn at the roundabout in the normal way by using the non-segregated part of the approach. This would allow the segregated lane to be closed where this is considered to be the safer option in the event of a breakdown.

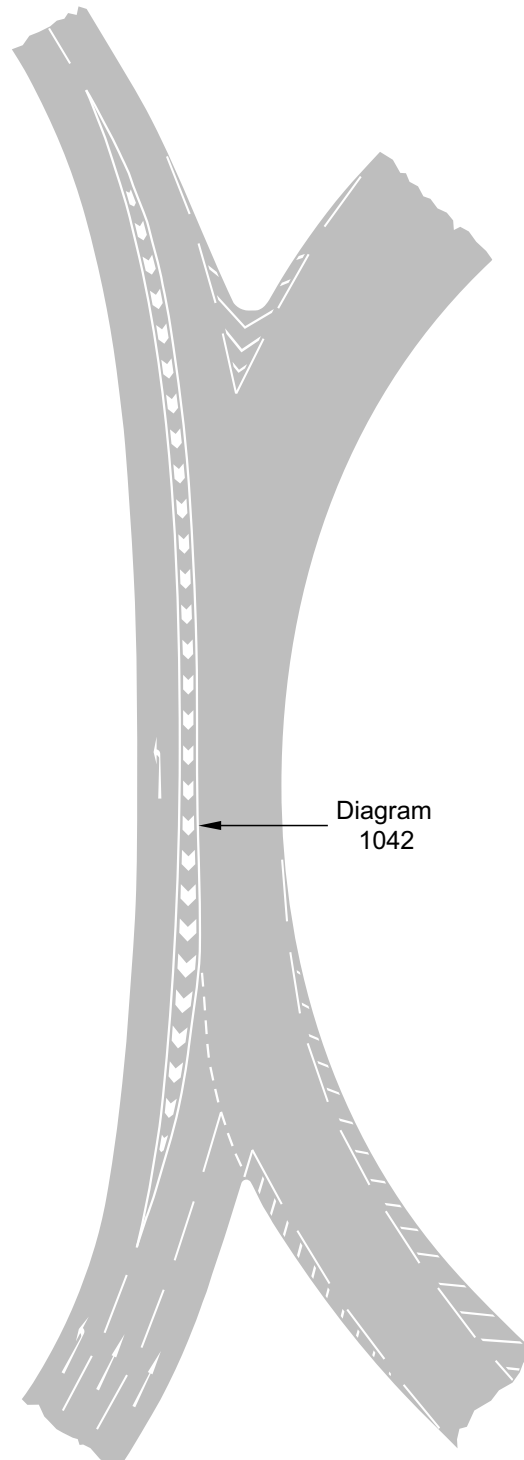

Figure 6-7 Example of a segregated left-turn lane

6.9 Yellow box markings

6.9.1. Schedule 9 General Direction 9 prohibits the use of yellow box markings (S9-6-25, see section 8) on roundabouts unless the entry of traffic is under full-time signal control on that part of the roundabout where the marking is to be provided. This is because a circulating

vehicle has priority over those entering. If it stops to avoid obstructing the box when its exit is blocked, thereby releasing the flow of entering vehicles, there is likely to be uncertainty over re-establishing right of way when the exit is clear again. Moreover, a vehicle stopped in an outer lane might obscure vehicles lawfully continuing to circulate on the inner lanes (whose exit might not be blocked) from the view of drivers entering the roundabout. Yellow box markings must not be used where part time signals are in operation.

6.9.2. Although the Directions do not prohibit the use of the “KEEP CLEAR” marking (diagram 1026, S11-4-16) on roundabouts, there are still the potential problems of obscuration of sight lines and re-establishing priorities. These risks should be assessed carefully when considering whether the marking might help resolve problems caused by exit blocking.

6.10 Transverse yellow bar markings

6.10.1. Transverse yellow bar markings are used in certain conditions on high speed approaches to roundabouts, either on the main carriageway or on an exit slip road. They have been shown to be effective in reducing accidents associated with speed adaptation, i.e. where drivers have been travelling at sustained high speed for long periods. There is little evidence that they reduce collisions in other circumstances. The types of accidents most likely to be influenced are single vehicle and overrun accidents. The markings should not be used in an attempt to reduce speeds at sharp bends or other hazards. Unless there is a very strong case due to the accident record, the markings are not appropriate on slip roads, or if there is a segregated left-turn lane for the roundabout, or at roundabouts controlled by traffic signals. On approaching a green signal, some drivers will slow down in response to the markings, whilst others will maintain speed in an attempt to beat a change to red.

6.10.2. Before use of the markings is contemplated, it is essential to ensure that all standard signing has been correctly installed and is of the appropriate size (see Chapter 4). All signs should be checked to ensure they are in good condition and not obscured e.g. by vegetation, and sited at the correct distances from the junction. Only then should treatment with yellow bar markings be considered.

6.10.3. The markings are prescribed as diagram 1067 (S11-4-35) and should normally be considered only where the following criteria are met:

- a) the carriageway on which they are to be laid is on the approach to a roundabout on a motorway or dual carriageway road subject to the national speed limit, either on the main carriageway or on an exit slip road),
- b) there is at least 3 km of dual carriageway in advance of the site, with no major intersections or bends with a horizontal radius less than the desirable minimum for a 120 kph design speed shown in table 3 of TD 9 ‘Highway Link Design’,
- c) the road is subject to the national speed limit, and
- d) the accident record for the roundabout includes at least three accidents involving personal injury during the preceding three years, in which speed on the relevant approach was a contributory factor.

6.10.4. Each approach to a given roundabout is treated as a separate site and the use of the markings on each approach must be justified independently. The application of the criteria in **6.10.3** will ensure that the markings are used only at sites where they are likely to make a positive contribution to safety.

6.10.5. The marking consists of 90 yellow transverse bars on main carriageways, and 45 on slip roads. The bars are 600 mm wide, and are laid at right angles to the centre line of the

carriageway (see **Figure 6-8** for details of the layout on a main carriageway; see also **6.10.6** and **6.10.7**). The first bar is laid at a distance of 50 m measured along the centre line of the carriageway in advance of the Give Way line. Successive bars are spaced in accordance with the running measurements in **Table 6-1** for main carriageways and in **Table 6-2** for slip roads. These distances are prescribed by S11-6-14 and S11-6-15 respectively and must not be varied.

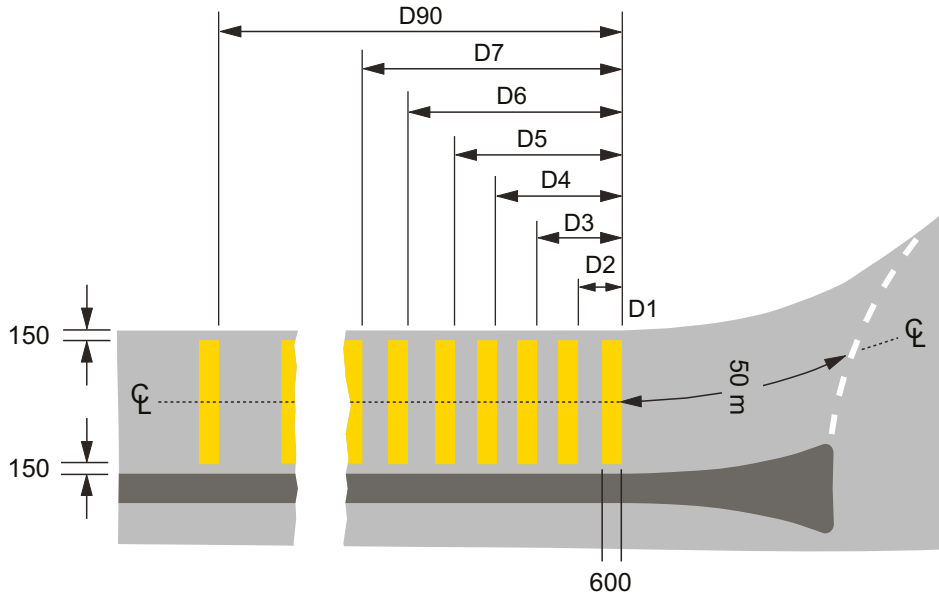

Figure 6-8 Diagram 1067 (S11-4-35)

6.10.6. To assist surface water drainage, each end of each bar is terminated 150 mm from the edge of the carriageway or the edge line marking if provided. This may be increased to 750 mm (S11-5-52), where there is a particular drainage problem, or if there are significant numbers of cyclists. Bars should not be extended across hard strips or hard shoulders as this would give the impression that these are traffic lanes.

6.10.7. Skid resistance of the bars should not be less than 55 (class S3 in BS EN 1436). Drop-on glass beads should not be applied. The bars should not exceed 5 mm in thickness, and the combined thickness of the bars and any superimposed marking must not exceed 6 mm. Depending on the materials used, some thinner markings might need more frequent renewal. However, they are less likely to result in noise levels which are unacceptable to local residents.

Table 6-1 Spacing of bars on main carriageway

Bar No.	Distance from D1 (m)	Bar No.	Distance from D1 (m)	Bar No.	Distance from D1 (m)	Bar No.	Distance from D1 (m)	Bar No.	Distance from D1 (m)
D1	0.00	D19	53.55	D37	117.75	D55	195.35	D73	289.60
D2	2.75	D20	56.80	D38	121.70	D56	200.10	D74	295.45
D3	5.50	D21	60.10	D39	125.65	D57	204.90	D75	301.30
D4	8.25	D22	63.45	D40	129.70	D58	209.80	D76	307.25
D5	11.05	D23	66.80	D41	133.75	D59	214.70	D77	313.30
D6	13.90	D24	70.15	D42	137.85	D60	219.70	D78	319.35
D7	16.80	D25	73.60	D43	142.00	D61	224.70	D79	325.55
D8	19.70	D26	77.05	D44	146.15	D62	229.80	D80	331.75
D9	22.60	D27	80.55	D45	150.40	D63	234.90	D81	338.15
D10	25.55	D28	84.10	D46	154.65	D64	240.10	D82	344.65
D11	28.55	D29	87.65	D47	158.95	D65	245.40	D83	351.35
D12	31.60	D30	91.30	D48	163.35	D66	250.70	D84	358.30
D13	34.65	D31	94.95	D49	167.75	D67	256.10	D85	365.50
D14	37.70	D32	98.65	D50	172.25	D68	261.50	D86	373.20
D15	40.80	D33	102.40	D51	176.75	D69	267.00	D87	380.90
D16	43.95	D34	106.15	D52	181.30	D70	272.60	D88	388.60
D17	47.15	D35	110.00	D53	185.95	D71	278.20	D89	396.25
D18	50.35	D36	113.85	D54	190.60	D72	283.90	D90	403.95

Table 6-2 Spacing of bars on slip roads

Bar No.	Distance from D1 (m)	Bar No.	Distance from D1 (m)	Bar No.	Distance from D1 (m)	Bar No.	Distance from D1 (m)	Bar No.	Distance from D1 (m)
D1	0.00	D10	26.90	D19	59.20	D28	98.20	D37	145.50
D2	2.75	D11	30.20	D20	63.15	D29	103.00	D38	151.35
D3	5.55	D12	33.55	D21	67.20	D30	107.90	D39	157.40
D4	8.45	D13	37.00	D22	71.35	D31	112.90	D40	163.60
D5	11.35	D14	40.50	D23	75.60	D32	118.00	D41	170.00
D6	14.35	D15	44.05	D24	79.90	D33	123.30	D42	176.70
D7	17.40	D16	47.70	D25	84.30	D34	128.70	D43	183.90
D8	20.50	D17	51.45	D26	88.80	D35	134.20	D44	191.60
D9	23.70	D18	55.30	D27	93.45	D36	139.80	D45	199.30

6.11 Special cases

6.11.1. It is sometimes expedient to give traffic from one arm of a roundabout priority over traffic already circulating. This might be necessary if the layout is unusual or there is a heavily dominant flow. It is likely to be more appropriate on urban roads, where speeds are lower, than in rural areas. As such a layout operates contrary to the conventional Give Way rule, it can be confusing and potentially dangerous. Traffic signal control may be a better option.

6.11.2. Where signalling the roundabout is not practicable, the layout in [Figure 6-9](#) may be used. The mandatory Give Way lines and triangle marking (diagrams 1003A and 1023A; S9-6-3

and S9-6-4 respectively) must be laid across the circulating area of the roundabout at the point of entry of the priority road. The Give Way markings should be reinforced by the provision of two upright GIVE WAY signs to diagram 602 (S9-2-2) as shown.

6.11.3. Give Way markings to diagram 1003A may also be used at conventional roundabouts, in conjunction with upright signs to diagram 602 and the marking to diagram 1023. This applies where there might otherwise be uncertainty about priorities, e.g. where drivers might be confused by a green signal at a pedestrian crossing immediately before the roundabout.

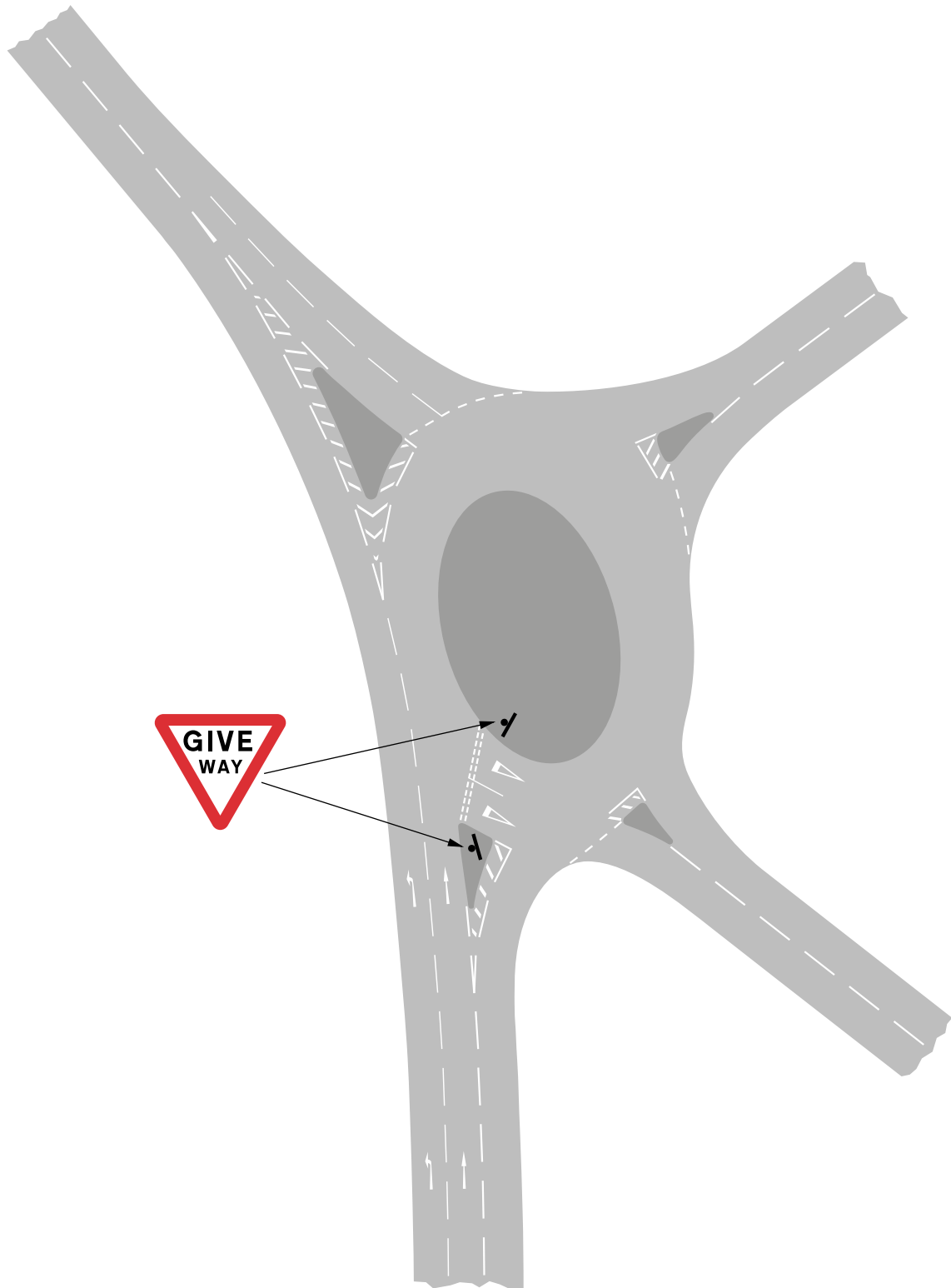

Figure 6-9 Example of a special layout of a roundabout

7.1 Design

7.1.1. Grade separated junctions may involve taper merges and taper diverges, or the gain or loss of lanes, or a combination of these. As junctions become more complex, so road marking layouts become more complicated. It is not practicable to detail all possibilities, but the standard principles should be followed. Reference should be made to TD 22 'Layout of Grade Separated Junctions' and TD 27 'Cross-Sections and Headrooms' for detailed design guidance. When designing a complex layout, it should be borne in mind that it must be capable of being signed and marked in a way that drivers can readily understand.

7.2 Taper merges and diverges

7.2.1. The layout of markings and road studs at the simplest grade separated junction is shown in [Figure 7-1](#). The principal dimensions are detailed in [Table 7-1](#) and [Table 7-2](#). This arrangement is suitable for one or two-lane exit and one-lane entry slip roads.

Table 7-1 Taper-merge and lane-gain markings

Road type	Speed limit (mph)	Length of entry taper (m) (1)	Nose taper for minimum angle at nose (2)	Nose length (m) (3)	Length of ghost island tail (m) (4)	Width of diag 1010 marking (mm)
Rural motorway	70	205	1 in 40	115	180	200
Rural dual carriageway	70	150	1 in 30	85	150	200
	60 or less	130	1 in 25	75	150	150
Urban road	60	95	1 in 15	50	n/a	150
	50 or less	75	1 in 12	40	n/a	150

NOTE: Numbers (1) to (4) in the column headings relate to features shown on [Figure 7-1](#) to [Figure 7-6](#) and [Figure 7-10](#).

Table 7-2 Taper diverge and lane-drop markings

Road type	Speed limit (mph)	Length of exit taper (m)		Nose taper for minimum angle at nose (7)	Nose length (m) (8)	Width of diag 1010 marking (mm)
		1 lane generated (5)	2 lanes generated (6)			
Rural motorway	70	170	185	1 in 15	80	200
Rural dual carriageway	70	150	150	1 in 15	70	200
	60 or less	130	130	1 in 15	70	150
Urban road	60	95	110	1 in 15	50	150
	50 or less	75	90	1 in 12	40	150

NOTE: Numbers (5) to (8) in the column headings relate to features shown on [Figure 7-1](#), [Figure 7-7](#) to [Figure 7-9](#), [Figure 7-11](#) and [Figure 7-12](#).

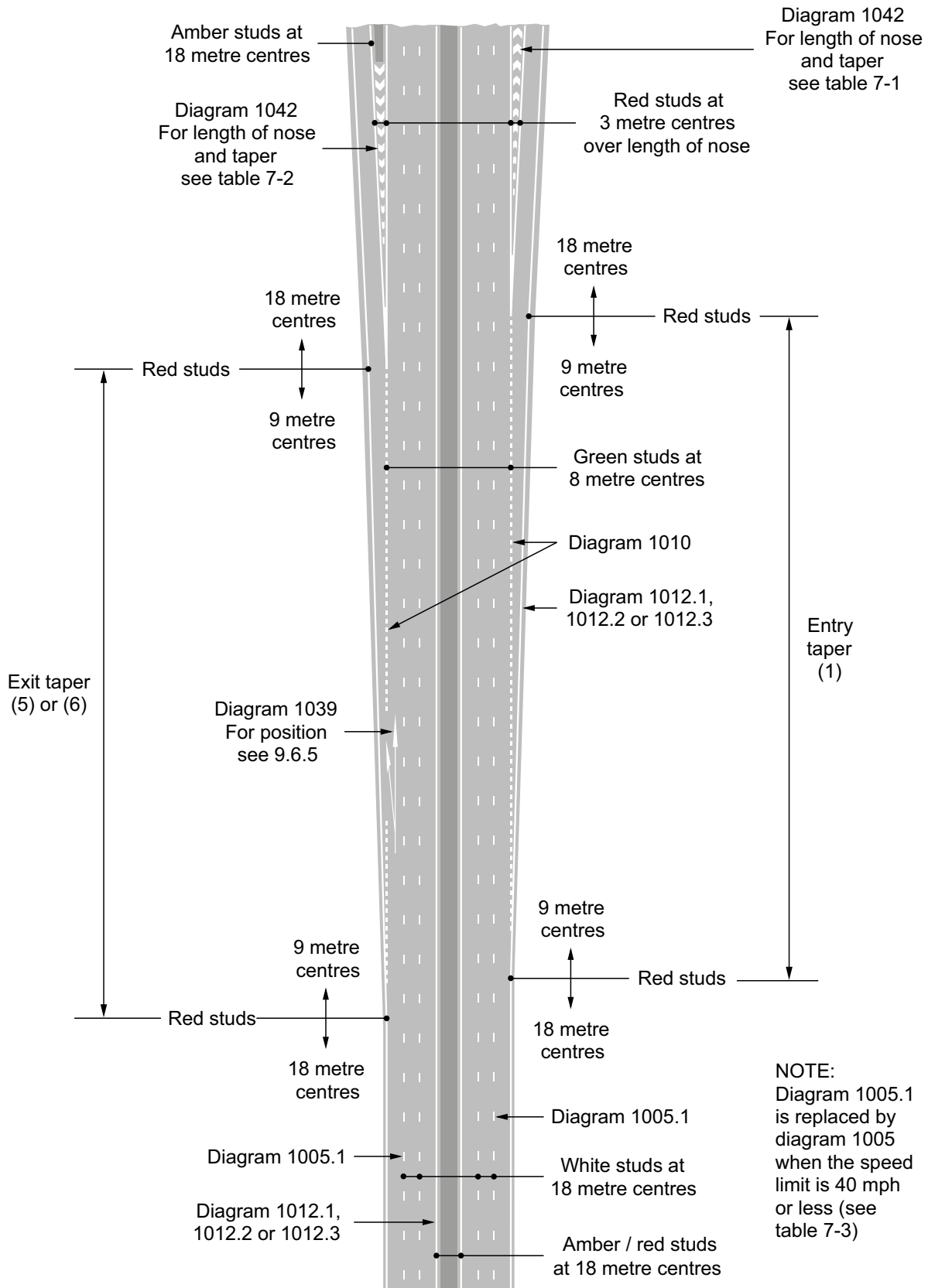

Figure 7-1 Simple taper merge and diverge

7.2.2. The nosing of the slip road is marked using diagram 1042 (S9-6-22), with red studs provided at 3 m centres along the outside of both edges. The lane line marking to diagram 1005 or 1005.1 (S11-4-4 and S11-4-5 respectively) on a two-lane exit slip road commences at the start of the nose as shown for a lane-drop in **Figure 7-7**.

7.2.3. The edge line should be continued along the slip road. Where raised rib markings are used, the rib spacing should be reduced to 250 mm on motorway slip roads. Red reflecting road

studs should be used on the nearside and amber on the off side, both at 18 m centres except as detailed in [7.2.4](#).

7.2.4. The main carriageway edge line should change to diagram 1010 (S11-4-10), with green reflecting road studs at 8 m centres, across the slip road over which traffic joins or leaves. Along the same length, the spacing of the red studs associated with the edge line to diagram 1012.1, 1012.2 or 1012.3 (S11-4-11 to S11-4-13 respectively) at the nearside of the slip road is reduced from 18 m to 9 m. The bifurcation arrow to diagram 1039 (S11-4-22) should be used in accordance with [9.6.5](#) at the lengths specified in [9.6.3](#).

7.2.5. Conventional lane lines to diagram 1005 or 1005.1 (S11-4-4 and S11-4-5, see [Table 7-3](#)) on the main carriageway should be continued through the junction and not replaced by warning lines to diagrams 1004 or 1004.1 (S11-4-2 and S11-4-3).

Table 7-3 Size of markings in figures 7-1 to 7-12

Diagram number		Length (m) x Gap (m) x Width (mm)			
Speed limit (mph)		Speed limit (mph)			
40 or less	50 to 70	40 or less	50	60	70
1004	1004.1	4 x 2 x 100	6 x 3 x 150	6 x 3 x 150	6 x 3 x 150
1005	1005.1	1 x 5 x 100	2 x 7 x 150	2 x 7 x 150	2 x 7 x 150
1010	1010	1 x 1 x 100	1 x 1 x 150	1 x 1 x 150	1 x 1 x 200

7.2.6. An entry layout for two-lane slip roads is shown in [Figure 7-2](#), allowing each lane of the slip road to join separately. This is referred to as a ghost island merge in TD 22. The ghost island between the joining lanes should be to diagram 1042, bordered by red studs at 3 m centres. The width of this marking at its widest point, where the first merge ends, should be at least 2 m. This layout is suitable where the main line flow is light, the main carriageway is three or more lanes wide and the merging flow exceeds the capacity of a single lane. Where main line flow is high, a lane-gain would normally be used (see [7.3](#)). A ghost island merge is not used on urban roads; a lane reduction on the slip road as shown in [Figure 7-3](#) should be used (see [7.2.7](#)). A lane-reduction taper merge is not suitable for rural motorways or rural dual carriageway roads.

7.2.7. A lane-reduction taper merge on an urban slip road (see [Figure 7-3](#)) is effected by the use of hatched markings to diagram 1040.3 (S11-4-24, see [2.7.4](#)) with amber studs at 9 m centres. The length of the taper on the slip road should be determined from [Table 7-4](#), with the full reduction in width being achieved at least 50 m in advance of the back of the nose. The hatching is continued as diagram 1042 to form the nose at the end of the slip road. Additionally, at least two deflection arrows to diagram 1014 (S11-4-14) should be placed in the lane which is to be discontinued. The tip of the final arrow should be 30 m before the start of the taper and preceding arrows at intervals of 30 m in advance of that. The markings should be supplemented by signs to diagram 872.1 (S11-2-15). The dimensions of the nose and entry taper are given in [Table 7-1](#) applicable to urban roads.

Table 7-4 Taper for slip road lane reduction

85 percentile speed of private cars (mph)	Preferred minimum taper	Absolute minimum taper
Up to 30	1 in 40	1 in 20
31 to 40	1 in 40	1 in 30
41 to 50	1 in 45	1 in 40
51 to 60	1 in 50	1 in 50
Over 60	1 in 55	1 in 55

NOTE: The preferred minimum taper should be used wherever practicable; the absolute minimum should be used only where unavoidable (see TD 22).

7.3 Lane-gains

7.3.1. The principal dimensions for lane-gain layouts are given in [Table 7-1](#). There are two basic situations; the number of lanes gained will either be the same as, or less than, the number of lanes on the entry slip road (see [Figure 7-4](#) to [Figure 7-6](#)). Ahead arrows to diagram 1038 (S11-4-20) should be placed on the joining (additional) lane and on the original left lane of the main carriageway at the point they come together, to discourage premature lane changing.

7.3.2. Where the number of lanes gained equals the number of lanes on the entry slip road, the markings in [Figure 7-4](#) should be used. All lane markings to diagram 1005.1 on both the main carriageway and the slip road should change to 1004.1 as indicated (or from 1005 to 1004 on roads where the speed limit is not more than 40 mph; see [Table 7-3](#)). Where two lanes are gained, the warning lines on the main carriageway should continue for at least 200 m beyond the ghost island. If the slip road has only one lane, the ghost island is not used and the warning lines on the main carriageway should continue for at least 50 m beyond the end of the nose.

7.3.3. Where the number of lanes gained is less than the number of lanes on the entry slip road, there are two methods of carrying out the merge:

- a) the right-hand slip lane has a taper merge with the through carriageway before the left-hand slip lane is added ([Figure 7-5](#)). All lane markings to diagrams 1005 or 1005.1 should change to 1004 or 1004.1 respectively (see [Table 7-3](#)), commencing at the first sign to diagram 874 (S11-2-14) on the slip road and at least 200 m prior to the merge nose tip on the main carriageway. These markings should be continued for at least 50 m beyond the termination of the ghost island. Road markings to diagram 1010 should extend from the tip of the merge nose to the point where it meets the ghost island; or
- b) the left-hand slip lane has a taper merge with the additional main carriageway lane after the right-hand slip lane has been added to the through carriageway ([Figure 7-6](#)). In this option it is not easy for slower slip road traffic to merge into the faster lanes; it is also difficult to sign. Reference should be made to the appropriate overseeing authority before it is used.

7.3.4. In [Figure 7-4](#) to [Figure 7-6](#), the width of the ghost island (diagram 1042) at its widest point, i.e. the start of the tail, should be at least 2 m. Red studs are provided at 3 m centres along the outside of both edges. The length of the ahead arrows to diagram 1038 should be in accordance with [Table 9-1](#).

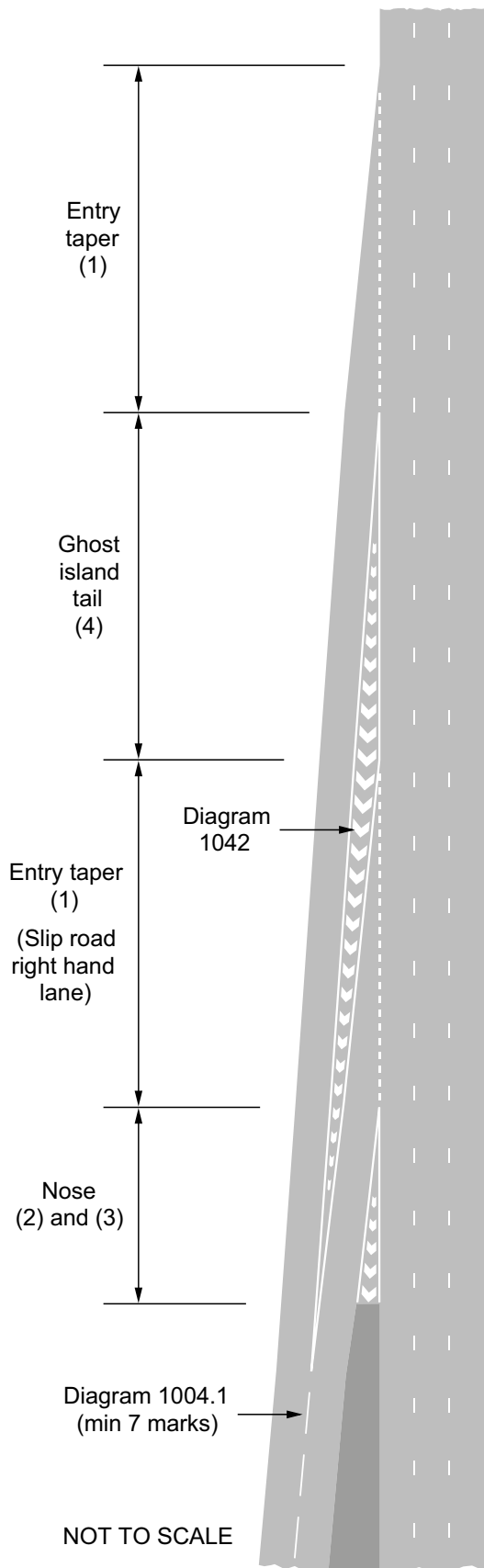

Figure 7-2 Ghost island merge from a two-lane slip road (urban roads only)

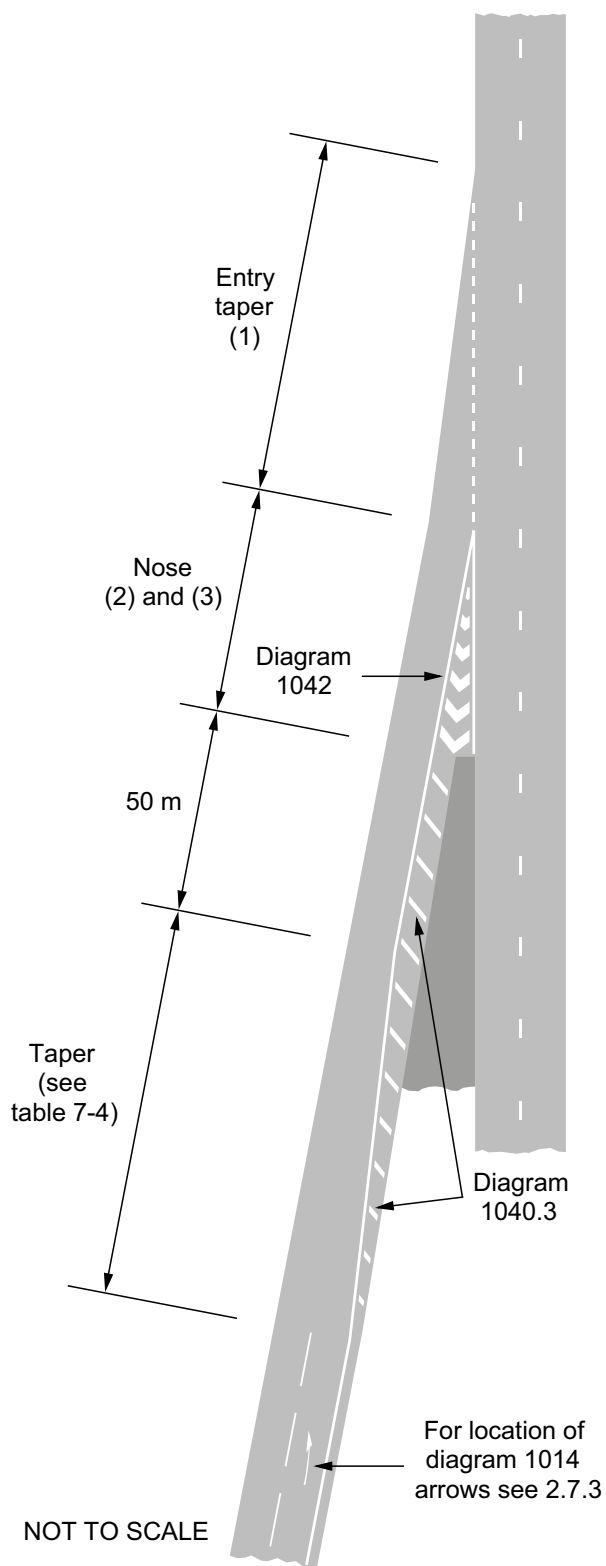

Figure 7-3 Single lane merge

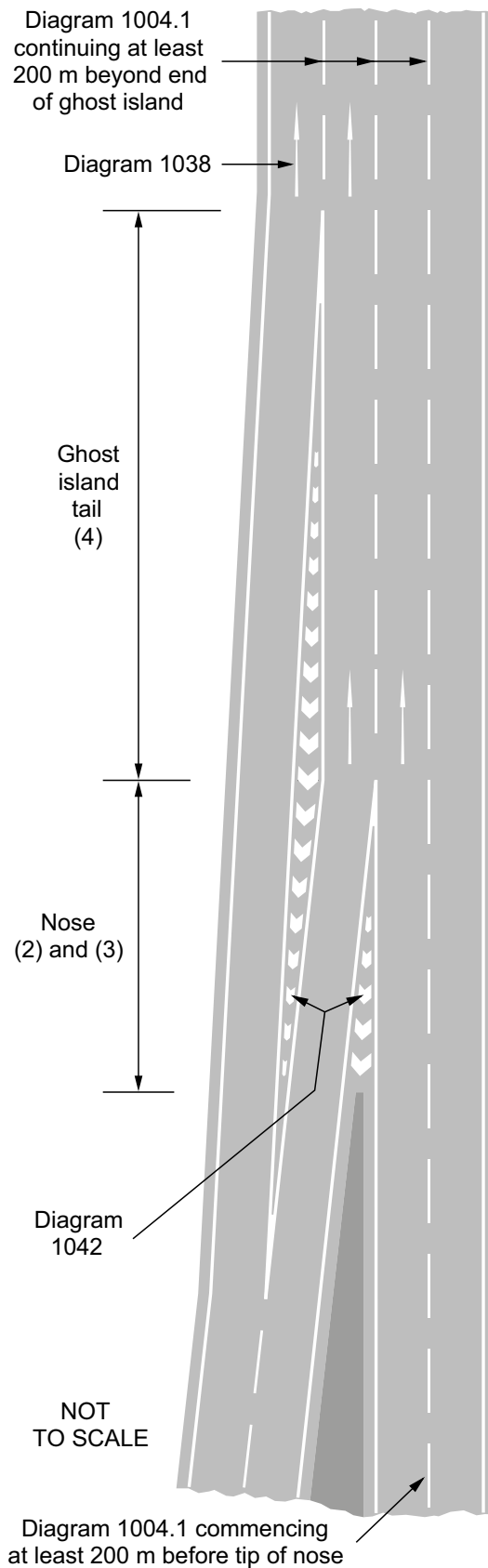
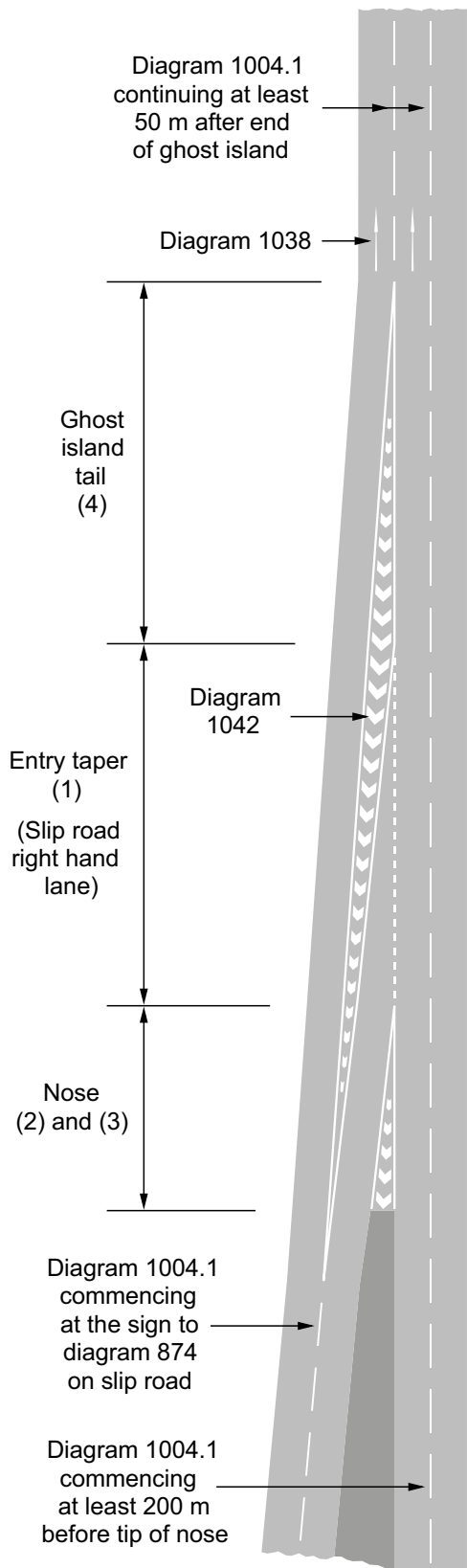
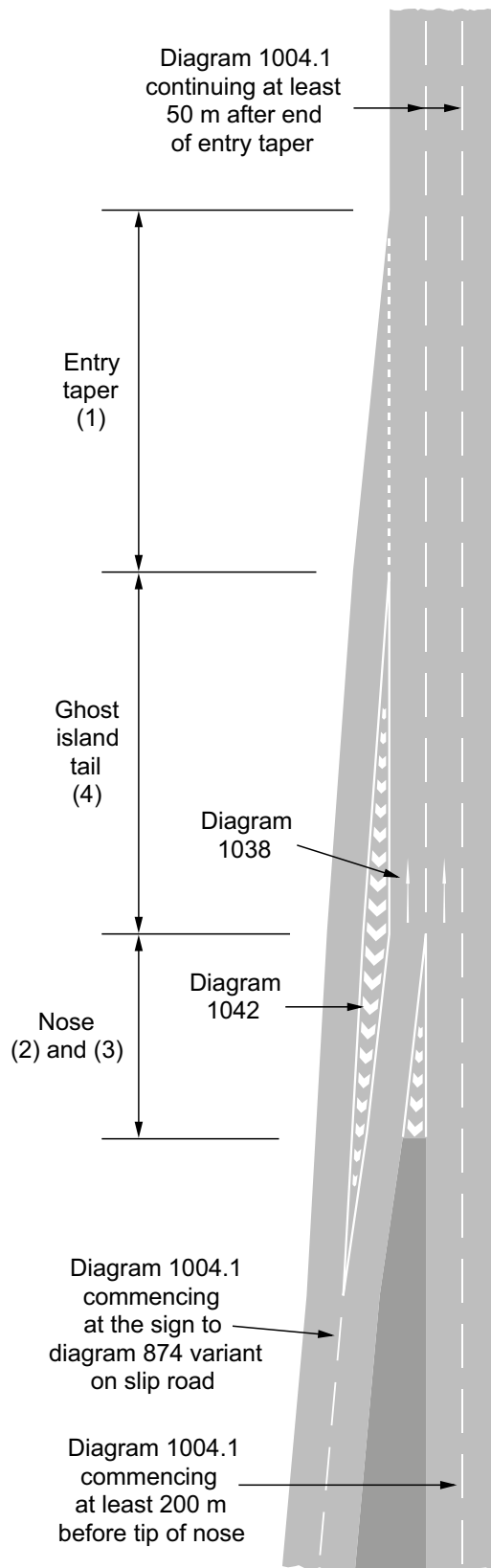

Figure 7-4 Two lane-gains from a two-lane slip road



NOT TO SCALE

Figure 7-5 Taper merge followed by lane-gain



NOT TO SCALE

Figure 7-6 Lane-gain followed by taper merge

7.4 Lane-drops

7.4.1. A standard lane-drop layout for high speed roads is shown in Figure 7-7. The lane marking dividing the through lanes from the lane or lanes to be dropped should change to diagram 1004.1 (S11-4-3, see Table 7-3 for width) at the one-mile advance direction sign. From the half-mile advance direction sign to the exit nose tip, the marking changes again to diagram

1010 (S11-4-10). Road studs used in conjunction with the diagram 1010 marking must be green. From the half-mile sign to the final advance direction sign, the studs will be spaced 18 metres apart, then closed up to 8 metre centres to the tip of the exit nose. Where the advance direction signs are sited at two thirds and one third of a mile from the junction, the lane-drop markings referred to above will commence at these sign positions with the stud spacings adjusted to suit. The appropriate widths and modules for these markings are detailed in [Table 7-3](#).

7.4.2. The principal dimensions for lane-drop layouts are given in [Table 7-2](#). The table indicates the length of the exit taper depending upon the number of extra lanes provided on the slip road. In the case of the lane-drop shown in [Figure 7-7](#), two lanes on the slip road represents an increase of one over the approach lane and therefore the taper length shown in the table should be as indicated under the heading (5). Where the number of lanes on the slip road is the same as the number of lanes dropped, there will not be an exit taper.

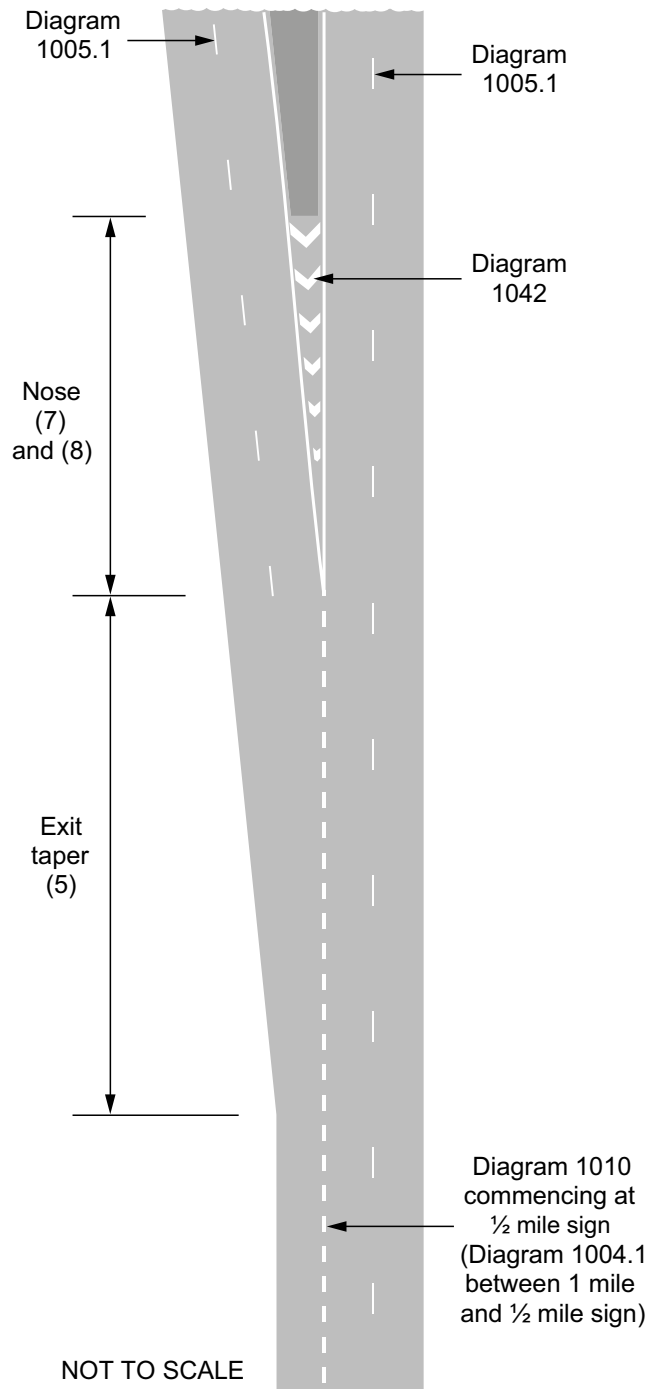

Figure 7-7 Lane-drop

7.5 Ghost island diverges

7.5.1. A junction exit marking which comprises both a lane-drop and a taper diverge, or a double diverge, is known as a ghost island diverge and is sometimes referred to as a “tiger tail” because the design of the associated upright sign and the narrow hatching resemble a tiger’s tail (see [Figure 7-8](#) and [Figure 7-9](#)). The layout shown in [Figure 7-8](#) combines a lane-drop with a taper diverge from lane two, whereas the layout in [Figure 7-9](#) comprises a double taper diverge. These arrangements increase the capacity of the junction and are likely to be appropriate where the exit flow is high. They should also help to prevent late manoeuvres where traffic moves into lane one immediately before the exit. Further guidance can be found in TD 22.

7.5.2. The advance informatory signs shown in [Figure 7-8](#) and [Figure 7-9](#) or their primary route equivalents (diagram 2017.1, S12-28-2 in the case of [Figure 7-8](#)) should always be used in conjunction with a ghost island diverge so that drivers have a clear indication of the junction layout. At least two verge-mounted signs should be provided. These supplement the standard advance direction signs, which will normally be gantry mounted and, in the case of a lane-drop, indicate the destinations for each lane. The distance to the junction shown in [Figure 7-8](#) and [Figure 7-9](#) may be omitted or varied in accordance with S18-3-7.

7.5.3. The lane marking dividing lane one from lane two in the case of a lane-drop ([Figure 7-8](#)) should change to diagram 1004.1 (S11-4-3, 150 mm wide) at the one-mile advance direction sign and continue through to the half-mile advance direction sign. From there to the ghost island tip, the marking changes again to diagram 1010 (S11-4-10, see [Table 7-3](#) for width). Road studs used in conjunction with the diagram 1010 marking in [Figure 7-8](#) must be green. From the half-mile sign to the final advance direction sign, the studs will be spaced 18 metres apart, then closed up to 8 metre centres to the tip of the ghost island.

7.5.4. Both the ghost island and the nose in [Figure 7-8](#) and [Figure 7-9](#) are marked using diagram 1042 (S9-6-22). Red studs are provided at 3 m centres along the outside of both edges of each marking. The marking to diagram 1010 along the edge of the taper diverge should be provided with green studs at 8 m centres. The bifurcation arrows to diagram 1039 (S11-4-22) should be 32 m long and used in accordance with [9.6.5](#). The conventional lane lines to diagram 1005.1 (S11-4-5, see [Table 7-3](#)) on the main carriageway should be continued through the junction and not replaced by warning lines.

NOTES:

1. Width of ghost island at widest point (start of exit taper) to be at least 2 m.
2. Length of exit taper (5) to be in accordance with table 7-2 (1 lane).
3. Nose taper (7) and length of nose (8) to be in accordance with table 7-2.
4. Length of ghost island head on rural motorways with a speed limit of 70 mph is 180 m (see table 4/4 in TD 22).
5. For positioning of the bifurcation arrow to diagram 1039 see 9.6.5. Length of the arrow is 32 m (see 7.5.4).
6. Size of lane markings to diagrams 1004.1, 1005.1 and 1010 to be in accordance with table 7-3.
7. Size of arrows to diagram 1038 to be in accordance with table 9-1.
8. The advance informatory sign shown below (motorway version) indicating the junction layout is to diagram 2904.2 (S12-28-1). A sign of this type should always be provided in addition to the main advance direction signing for the junction (see 7.5.2).
9. See 7.5.4 for details of studs required at diverge.

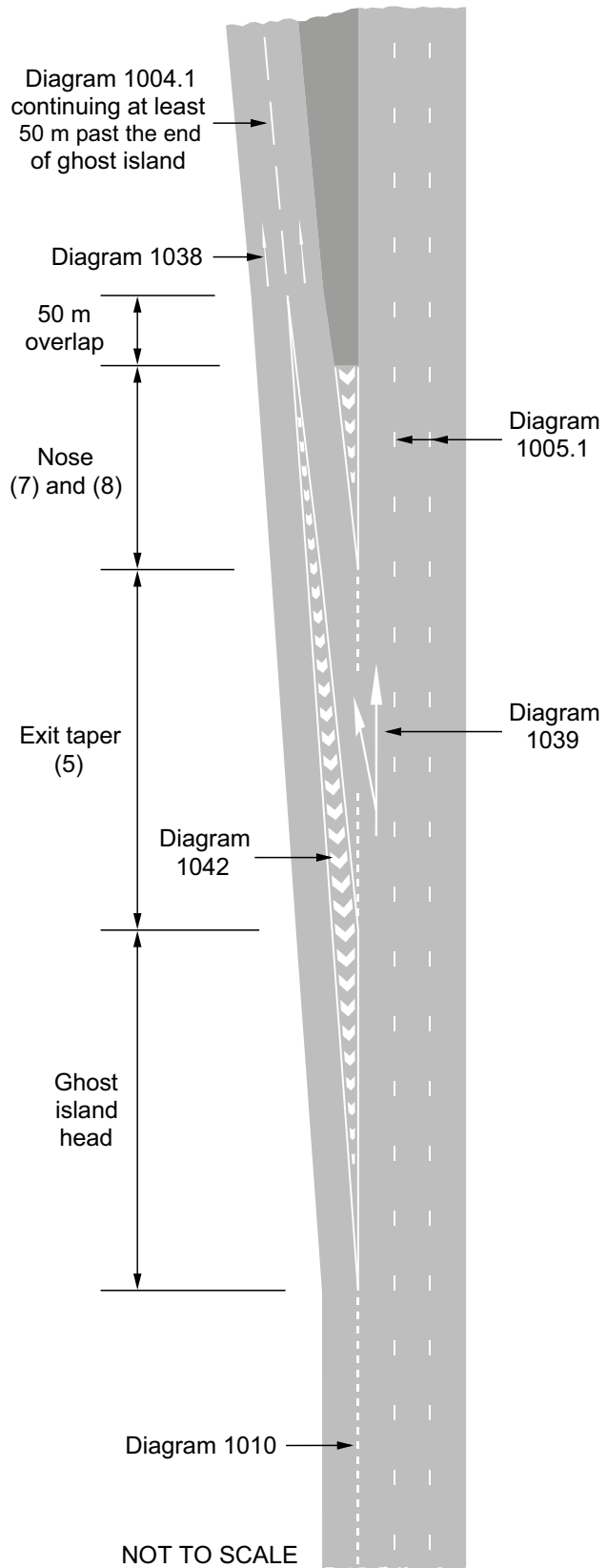
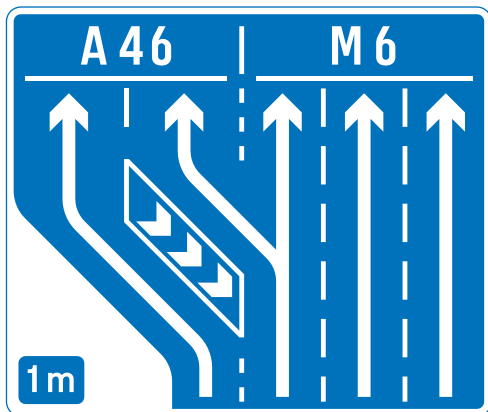

Figure 7-8 Ghost island diverge with lane-drop and taper diverge

NOTES:

1. Width of ghost island at widest point (start of second exit taper) to be at least 2 m.
2. Length of exit tapers (5) to be in accordance with table 7-2 (1 lane).
3. Nose taper (7) and length of nose (8) to be in accordance with table 7-2.
4. Length of ghost island head on rural motorways with a speed limit of 70 mph is 180 m (see table 4/4 in TD 22).
5. For positioning of the bifurcation arrows to diagram 1039 see 9.6.5. Length of each arrow is 32 m (see 7.5.4).
6. Size of lane markings to diagrams 1004.1, 1005.1 and 1010 to be in accordance with table 7-3.
7. Size of arrows to diagram 1038 to be in accordance with table 9-1.
8. The advance informatory sign shown below (motorway version) indicating the junction layout is to diagram 2904.2 (S12-28-1). A sign of this type should always be provided in addition to the main advance direction signing for the junction (see 7.5.2).
9. See 7.5.4 for details of studs required at diverge.

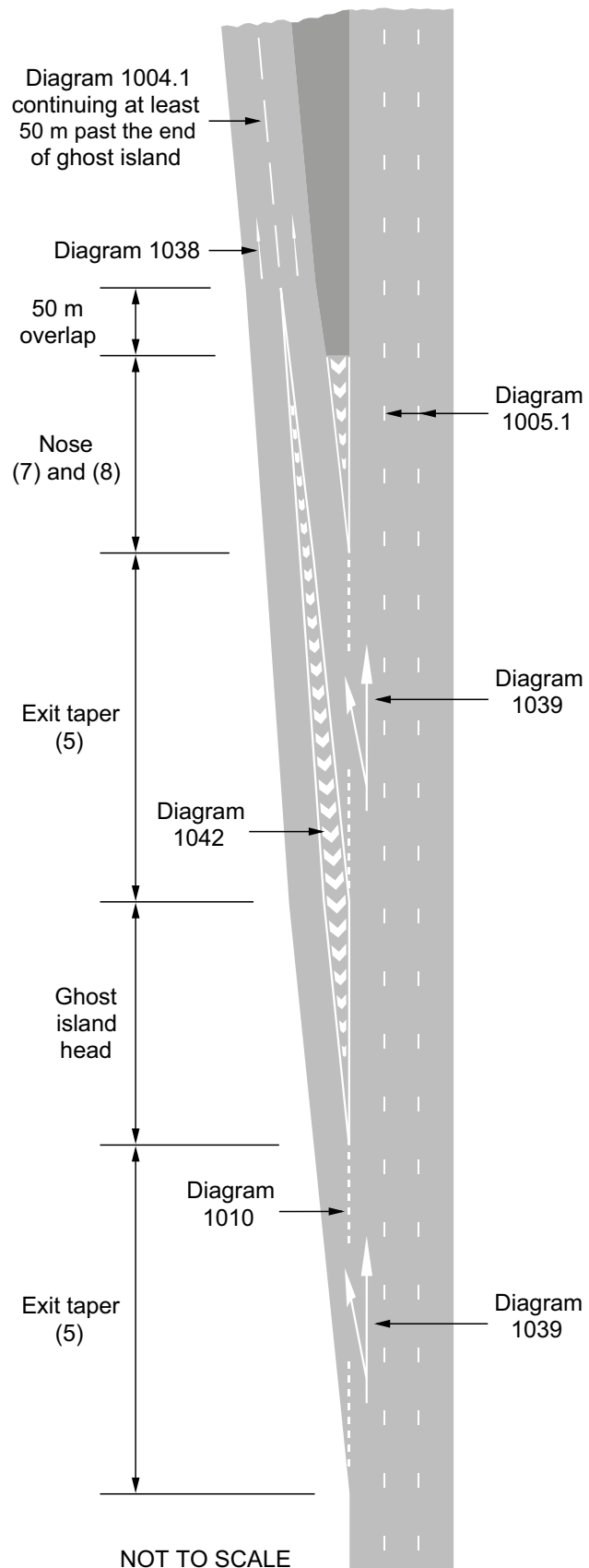
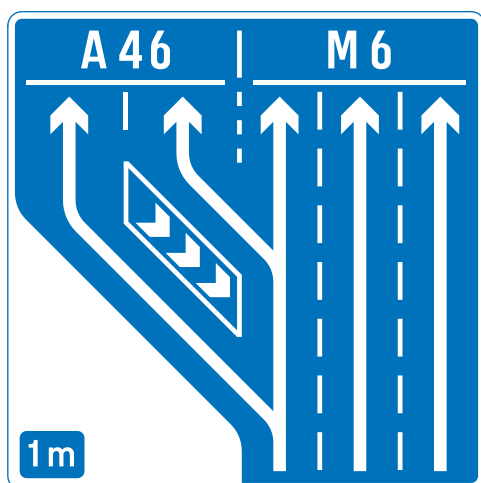

Figure 7-9 Ghost island diverge with double taper diverge

7.6 Auxiliary lanes

7.6.1. Auxiliary lanes are additional lanes at the side of the main carriageway (for design details see TD 22). They are formed by providing a section of parallel lane(s) between the nose and the entry or exit taper at a junction. They may be used with a taper merge or diverge and with a lane-drop (see [Figure 7-10](#) to [Figure 7-12](#)). Principal dimensions are given in [Table 7-5](#).

Table 7-5 Auxiliary lanes and tapers

Road type	Speed limit (mph)	Minimum length of auxiliary lane (merge) (m) (9)	Minimum length of auxiliary lane (diverge) (m) (10)	Length of auxiliary lane taper (m) (11)
Rural motorway	70	230	200	75
Rural dual carriageway	70	190	170	55
	60 or less	125	150	55
Urban road	60	160	125	40
	50 or less	100	100	40

NOTE: Numbers (9) to (11) in the column headings relate to features shown on [Figure 7-10](#) to [Figure 7-12](#).

7.6.2. Auxiliary lanes increase capacity by providing increased merge or diverge opportunity and additional space for weaving. However, in the case of a diverge, ghost island diverges as described in [7.5](#) are generally preferred (see para 2.49 in TD 22). The marking to diagram 1004.1 (S11-4-3) is used to separate the auxiliary lane from the main carriageway when used with a taper merge; the lane lines on the main carriageway are replaced by warning lines (i.e. the road marking layout is similar to that for a lane-gain). The marking between the auxiliary lane and the main carriageway is discontinued at the commencement of the taper and deflection arrows to diagram 1014 (S11-4-14) provided as shown in [Figure 7-10](#).

7.6.3. Where an auxiliary lane is added to a taper diverge or lane-drop, it provides two parallel lanes alongside the main carriageway. These two lanes are divided by the marking to diagram 1004.1 and separated from the main carriageway by the marking to diagram 1010 as shown in [Figure 7-11](#) (taper diverge) and [Figure 7-12](#) (lane-drop). As with other lane-drop layouts, the marking to diagram 1010 commences at the half-mile advance direction sign and is preceded by the marking to diagram 1004.1 between the one-mile and half-mile advance direction signs (see [7.4.1](#)).

7.7 Actively managed hard shoulders

7.7.1. Special arrangements apply for junctions on smart motorways with actively managed hard shoulders. Guidance should be sought from the appropriate overseeing authority.

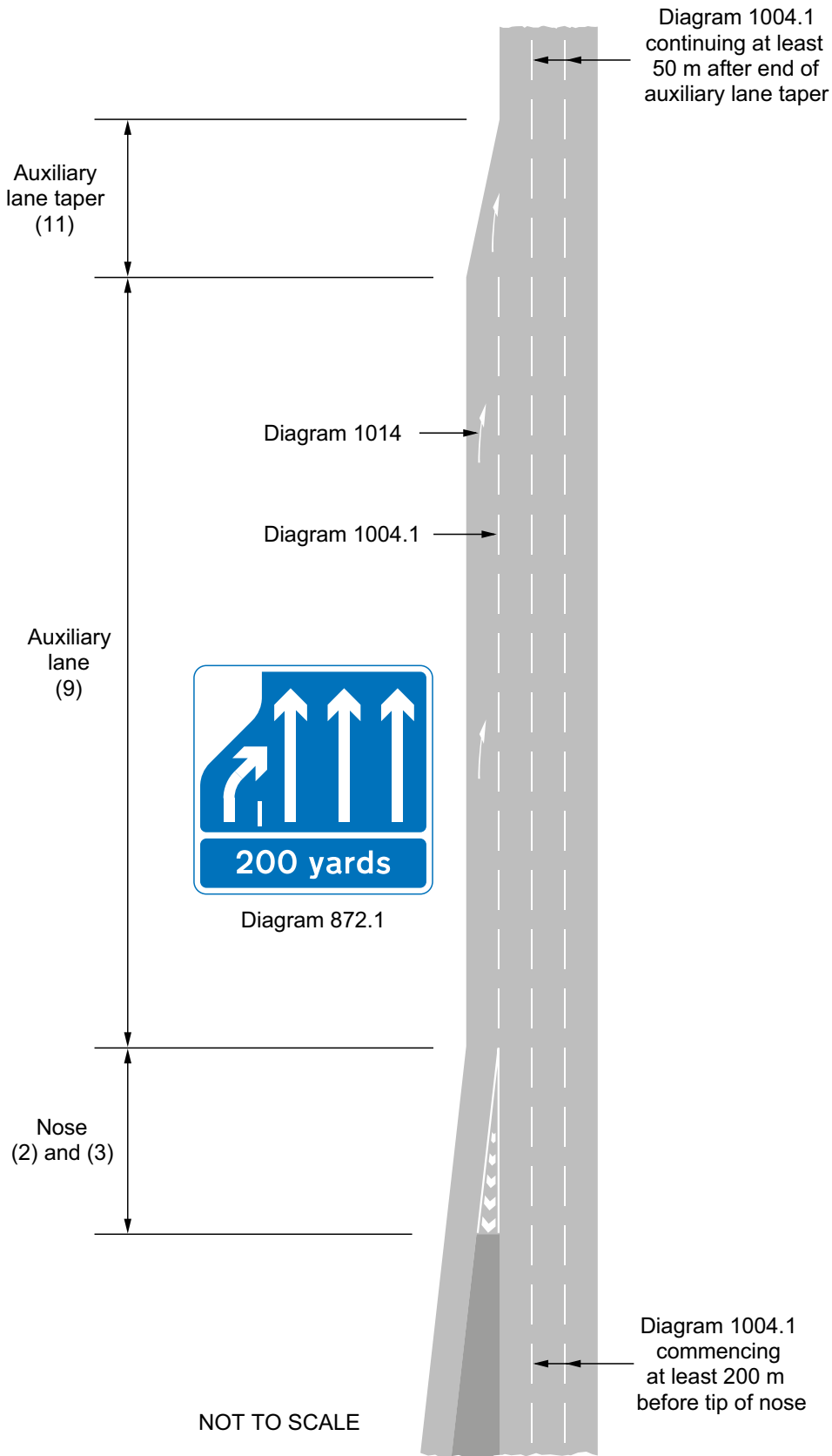

Figure 7-10 Taper merge with auxiliary lane

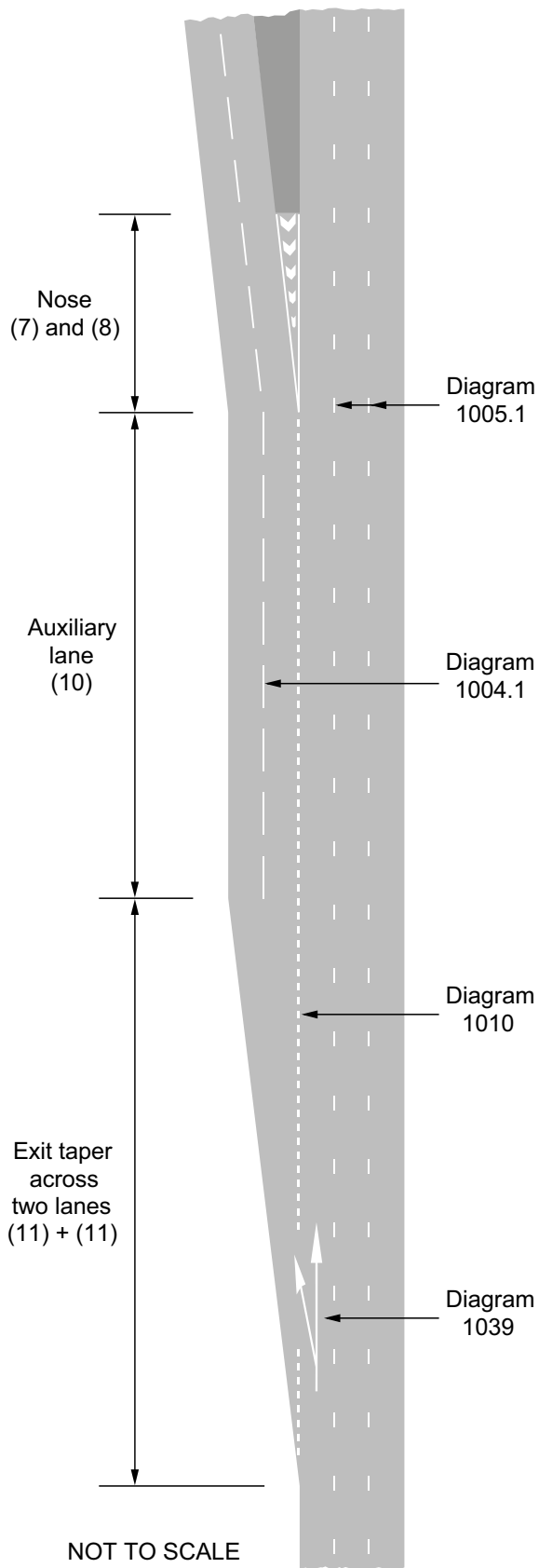

Figure 7-11 Taper diverge with auxiliary lane

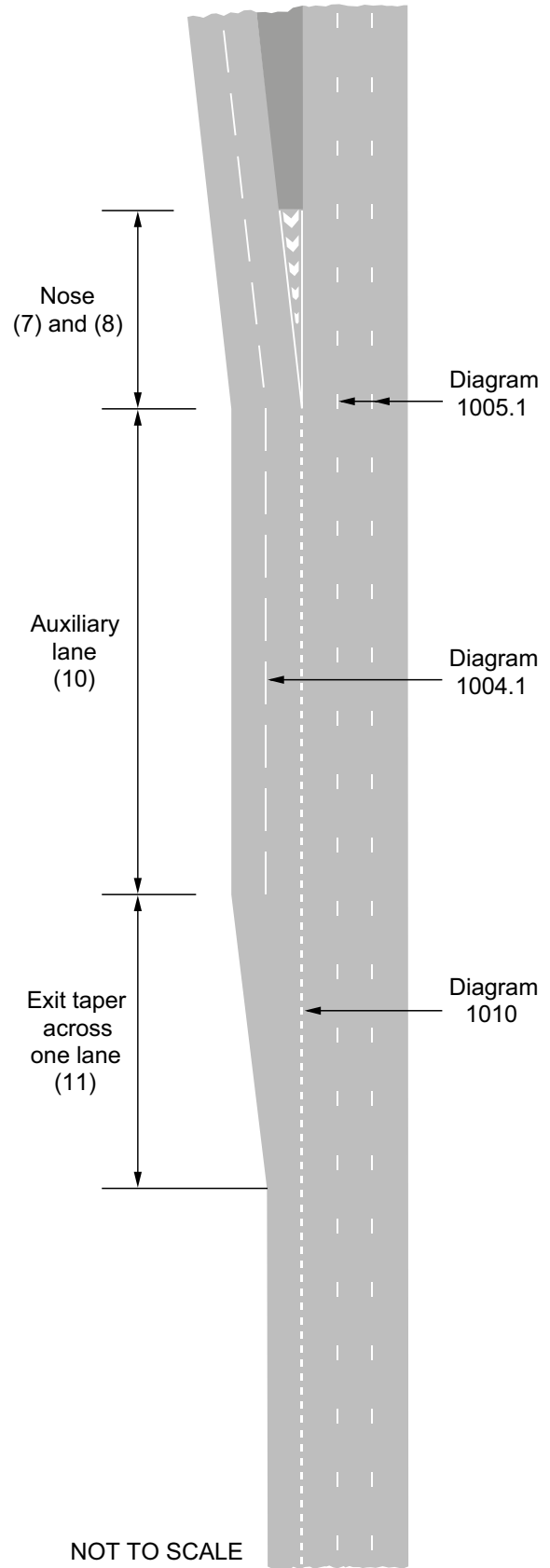

Figure 7-12 Lane-drop with auxiliary lane

8.1 Legal aspects

8.1.1. S9-7-11(6) specifies the meaning of a “box junction” in respect of diagram 1043 (S9-6-25) as an area of the carriageway where the marking has been placed and which is:

- a) at a junction between two or more roads (see [Figure 8-1](#) and [Figure 8-2](#)),
- b) at a gyratory system or roundabout, but only if it has full-time traffic signals (see [Figure 8-3](#) and [8.1.4](#)),
- c) along a length of a two-way road (other than at a junction), the carriageway of which is not greater than 4.5 metres wide at its narrowest point (see [Figure 8-4](#)), or
- d) a length of road adjacent to the vehicular entrance to the premises of a fire, police or ambulance station (see [8.3.3](#)).

8.1.2. The purpose of a yellow box marking is to mark an area of carriageway conveying the prohibition that a person must not cause a vehicle to enter the box junction so that the vehicle has to stop within the box junction due to the presence of stationary vehicles (S9-7-11). A vehicle waiting to turn right at a junction between two or more roads may stop within the box junction for so long as it is prevented from completing the right-turn by oncoming vehicles or other vehicles which are stationary whilst waiting to complete a right-turn.

8.1.3. The yellow box marking, when used at a road narrowing, conveys the prohibition that a person must not cause a vehicle to enter the box junction so that the vehicle has to stop within the box junction due to the presence of oncoming vehicles or other stationary vehicles beyond the box junction (see [8.3.7](#)).

8.1.4. Schedule 9 General Direction 9 does not permit the use of yellow box markings at roundabouts unless traffic entering the box is controlled by signals at all times (see [6.9.1](#)). Nor should they be used where traffic streams merge, as it will not be clear which stream has precedence when a gap appears.

8.1.5. Traffic Regulation Orders are not needed in order to install yellow box markings, although the police should always be consulted. The marking is subject to section 36 of the Road Traffic Act 1988 (S9-8-1).

8.2 Design and layout

8.2.1. The simplified marking relaxes many of the previous design rules, giving local authorities greater freedom to manage their roads, and allows the marking to be designed to cover all situations at junctions without the need for authorisation.

8.2.2. Applicable provisions to the marking are set out in S9-8-5(1) which permits the overall shape and size to be varied as appropriate. The marking is now fully flexible in terms of size, shape, outline, hatching angles and cut-outs.

8.2.3. When designing the marking, authorities should take in account that drivers must be able to comply with the requirements of seeing that their exit is clear before entering the box. This will obviously impose limits on the dimensions of the box depending on individual site conditions.

8.2.4. Although a 90-degree angle is no longer prescribed in respect of hatching, this should be the aim as far as possible in order to maximise visibility and maintain national consistency.

8.3 Suitability

8.3.1. Experience has shown that the marking improves traffic flow where previously there were delays due to vehicles blocking the junction and impeding the cross flow. At signal-controlled junctions, the queues of traffic left at the end of a green phase have been significantly reduced and there have been marked reductions in injury accidents, especially those involving pedestrians.

8.3.2. Half-boxes, in which only half the area of the junction is marked (see [Figure 8-2](#)) are appropriate at T-junctions and other junctions where the traffic blocks back from one direction only. Half-boxes should be used only on the minor road side of the main carriageway to allow emerging traffic to turn right where the queue of traffic in the major road is to the left. A half-box on the side of the road opposite a T-junction generally serves no useful purpose. Even though it will create a gap in a queue of traffic, drivers turning right from the minor road will not be able to enter the box as the exit will be obstructed.

8.3.3. Box markings shown in [Figure 8-1](#) and [Figure 8-2](#) are no substitute for traffic signals. They can however help to improve traffic flow at priority junctions where blocking back causes obstruction. These markings may also be used outside police, fire, ambulance stations or hospitals where traffic is likely to form queues on the main road. Unless the premises are located at a road junction, the half-box marking shown in [Figure 8-2](#) should be used (see [8.3.2](#)). The KEEP CLEAR marking to diagram 1026 (S11-4-16) or the KEEP CLEAR marking to diagram 1027.1 (S7-4-10; varied to omit the word "SCHOOL") should be considered as alternative markings where queuing on the main road is infrequent.

8.3.4. Not all junctions are suitable for the installation of box markings, and certain criteria should be applied before deciding whether a particular site should be marked. A traffic survey should be carried out to determine the extent of the problem, not only to assess the suitability of the junction for box marking but also to establish whether any alternative measures might be effective (e.g. re-timing or linking of traffic signals at adjacent junctions). A survey will also reveal what further measures might be needed, e.g. imposition of waiting and loading restrictions or re-location of bus stops.

8.3.5. Factors which influence a decision to provide box markings shown in [Figure 8-1](#) and [Figure 8-2](#) include the following:

- a) the junction should preferably, though not necessarily, be controlled by signals;
- b) blocking back from a junction ahead should occur under existing conditions, even if only for short periods;
- c) there should preferably be heavy traffic flows on both opposing arms of the junction. At unsignalled junctions with minor roads where blocking of the mouth of the minor road is infrequent, a KEEP CLEAR marking (see [11.4](#)) may be more appropriate;
- d) opposing roads at a junction should normally be in line with each other. The markings may, however, be used exceptionally at staggered junctions, particularly where the minor roads have a right hand stagger, provided the box length is not excessive, and irregular shapes can be avoided. Two half-boxes may be a practical substitute for a single large box in such circumstances;
- e) the carriageway beyond the junction should be free from obstruction (this may necessitate the imposition of waiting or loading restrictions, or the adjustment of bus stops on the lengths concerned);

- f) where a succession of junctions gives rise to blocking back, the establishment of a series of boxes should be considered, provided at least 20 m storage space can be maintained between successive boxes; and
- g) there should preferably not be a high proportion of right-turning traffic, since experience has shown that the effectiveness of the marking is reduced under these conditions.

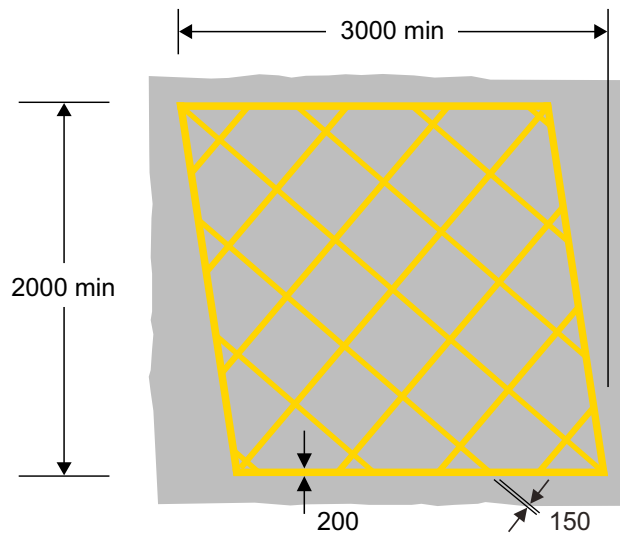

Figure 8-1 Diagram 1043 (S9-6-25) Yellow box marking which extends across the full width of the carrieway at a road junction (other than at a gyratory system or roundabout)

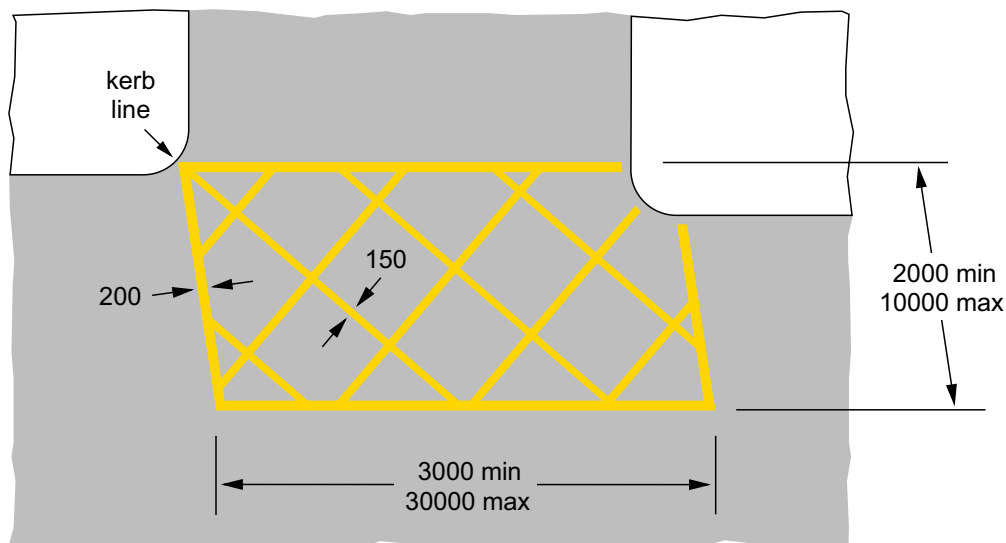

Figure 8-2 Diagram 1043 (S9-6-25) Yellow box marking which extends across part of the width of the carrieway at a road junction (other than at a gyratory system or roundabout) (variant)

8.3.6. A yellow box marking at a signal-controlled roundabout (see [Figure 8-3](#)) is likely to be appropriate where vehicles entering the roundabout form a queue across a free-running dedicated lane on the circulatory carrieway that leads to the next exit. A yellow box marking might also be appropriate where the exit route from a roundabout is congested and a queue forms across the previous entry arm, thus preventing vehicles from entering the roundabout at that point and proceeding along a free-running part of the circulatory carrieway that passes the next exit.

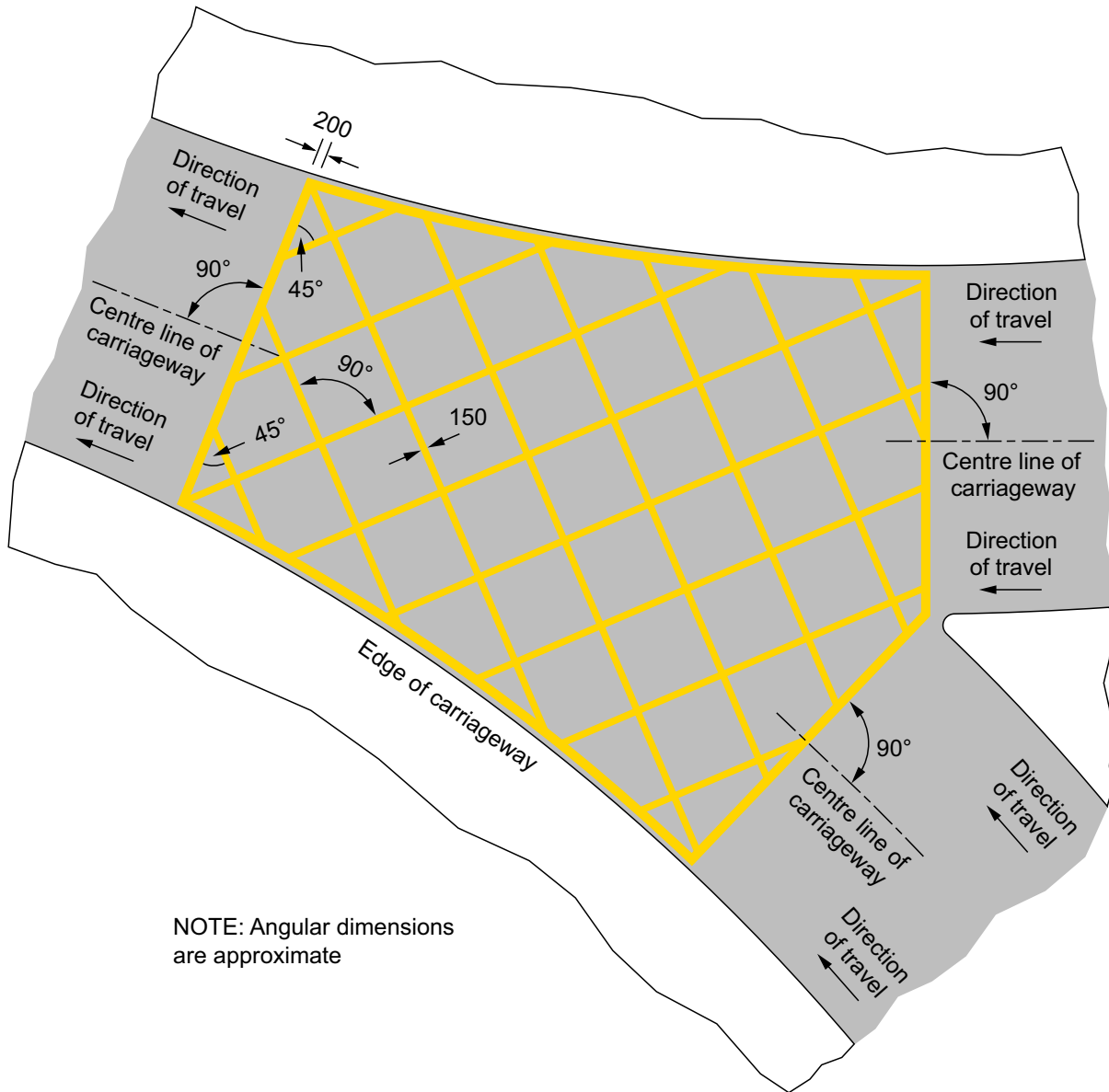
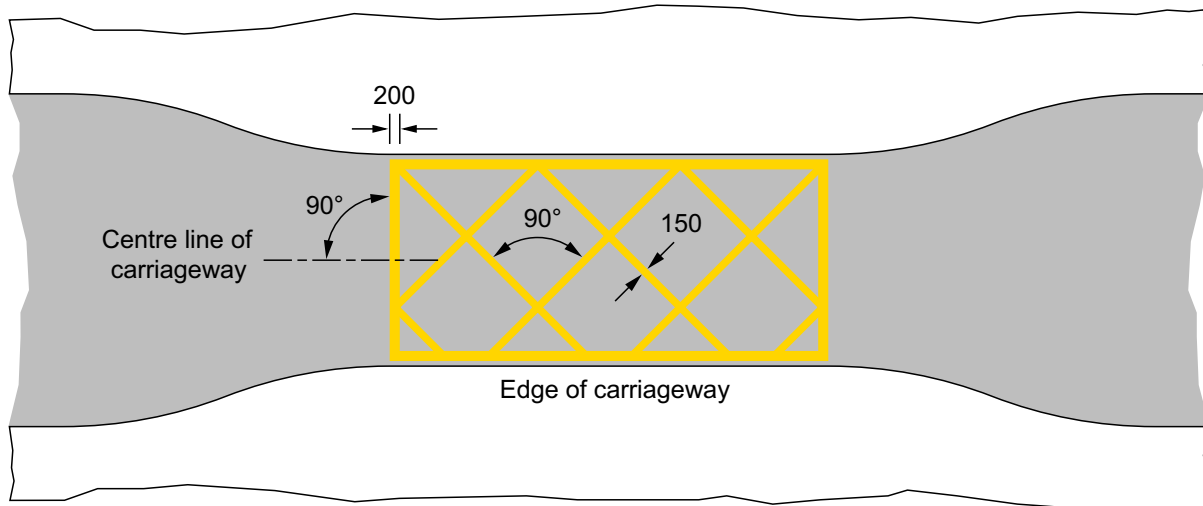

Figure 8-3 Diagram 1043 (S9-6-25) Yellow box junction marking on an area of carriageway at a gyratory system or roundabout where entry of traffic into that area is at all times controlled by traffic light signals (variant)

8.3.7. Where a narrow section of road is controlled by priority signs to diagrams 615 (S3-2-9) and 811A / 811B (S11-2-1) (see Chapter 3), a yellow box marking shown in **Figure 8-4**, may be used to prevent vehicles from queuing back into the section and obstructing the flow from the opposite direction. This is appropriate only where queues are likely to form, for example near a junction, beyond the priority section. The marking must not be used where the carriageway width at the narrowest point is greater than 4.5 m (see **8.1**). The longitudinal boundaries of the marking will not necessarily be formed by straight lines as they must always be adjacent to the edge of the carriageway.



NOTE: Angular dimensions are approximate

Figure 8-4 Diagram 1043 (S9-6-25) Yellow box marking at a road narrowing (variant)

8.3.8. A permitted variant to diagram 1043 allows the yellow box marking to be varied so that it may be used at a junction through which an on-street tram route passes. In this case the yellow markings must not be laid across the rails (S9-8-5(3)). The marking may also be varied to indicate the swept path of a tramcar (S9-8-5(4)). In this case, the yellow markings are terminated on either side of the swept path with a 200 mm wide boundary line as shown in **Figure 8-5**. In these circumstances, the swept path is for the guidance of tram drivers only, so it is not necessary to continue the marking to diagram 1010 (S11-4-10) through the box. For further details of tramway markings see Chapter 3.

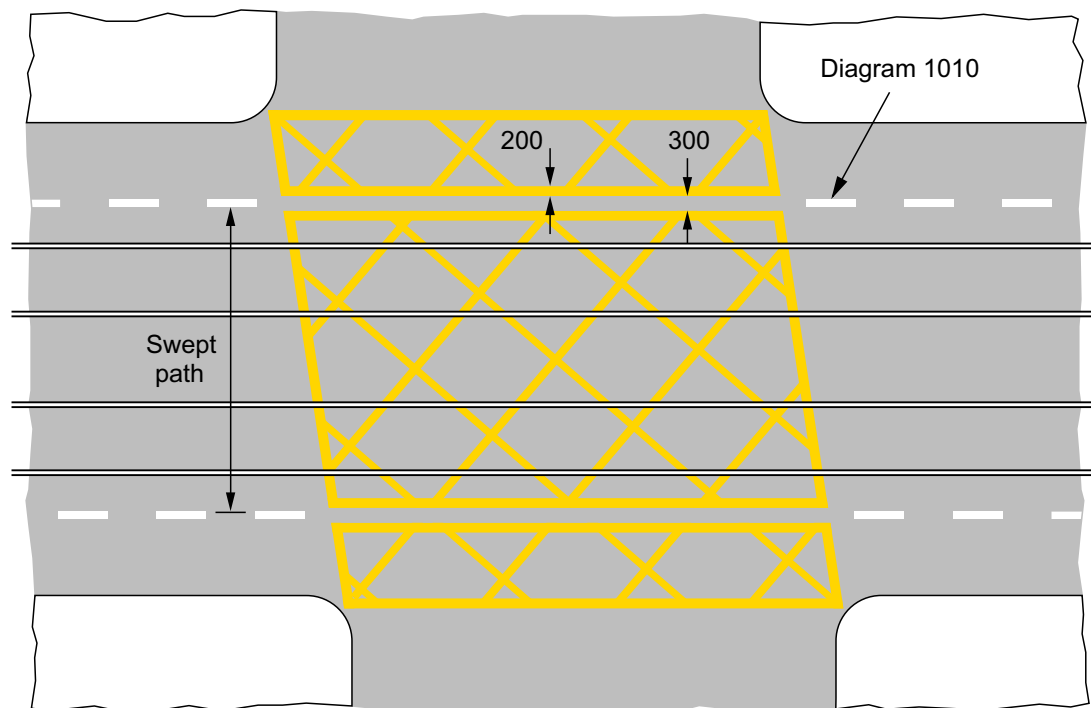

Figure 8-5 Tramway crossing a yellow box

8.4 Setting out

8.4.1. The marking to diagram 1043 consists of yellow lines forming a box enclosing cross-hatched diagonal lines. The diagonal lines are 150 mm wide and should normally be spaced about 2 m apart where the shortest boundary of the box is less than 9 m long, or 2.5 m apart where the shortest boundary of the box is 9 m or more. At a road junction, the box will normally have four straight sides, each being approximately transverse to the traffic flow on the

approach. Where the marking is used on a roundabout or at a road narrowing, the longitudinal boundary lines follow the kerb and will be curved as appropriate. It might also be appropriate for parts of the boundary line to be placed adjacent to the kerb at a road junction, particularly where the side roads are slightly staggered and the transverse line across the main road are at right angles (e.g. parallel to a traffic signal stop line). Also at a road junction, any corner may be cut away as shown in [Figure 8-6](#) to accommodate corner kerbs. The overall shape of the marking and the number of cross-hatched lines will vary to accord with the circumstances at the site (see S9-8-5(1)).

8.4.2. To set out the marking which extends across the full width of the carriageway at a road junction:

- a) mark transverse lines across each arm of the junction approximately at right angles to the flow of traffic (see [Figure 8-6](#));
- b) where the corners of the box have been cut away, complete the full box with construction lines; where the sides are still unequal in length, extend the short sides to X and Q using construction lines so that $PX = PY = YQ$;
- c) draw a main diagonal X-Y running from corner to corner of the notional box (either pair of opposite corners may be used),
- d) construct a diagonal line P-Q intersecting the first diagonal at right angles; it will not necessarily connect both corners of the yellow box; and
- e) set out the intermediate lines parallel to the diagonals, at grid intervals of approximately 2 m or 2.5 m as appropriate (see [8.4.1](#)).

8.4.3. Half-box markings should be designed in the same way as full box markings but with only half the box marked on the road (see [Figure 8-2](#)).

8.4.4. To set out the markings on a roundabout, at a road narrowing or adjacent to the vehicular entrance to the premises of a fire, police or ambulance station, the transverse lines should be placed approximately at right angles to the carriageway (the centre line where opposite kerb lines are not parallel, e.g. on a roundabout). The diagonal lines should be set at approximately 45° to one of the transverse boundary lines; in the case of a roundabout this should be at the exit from the box as shown in [Figure 8-3](#).

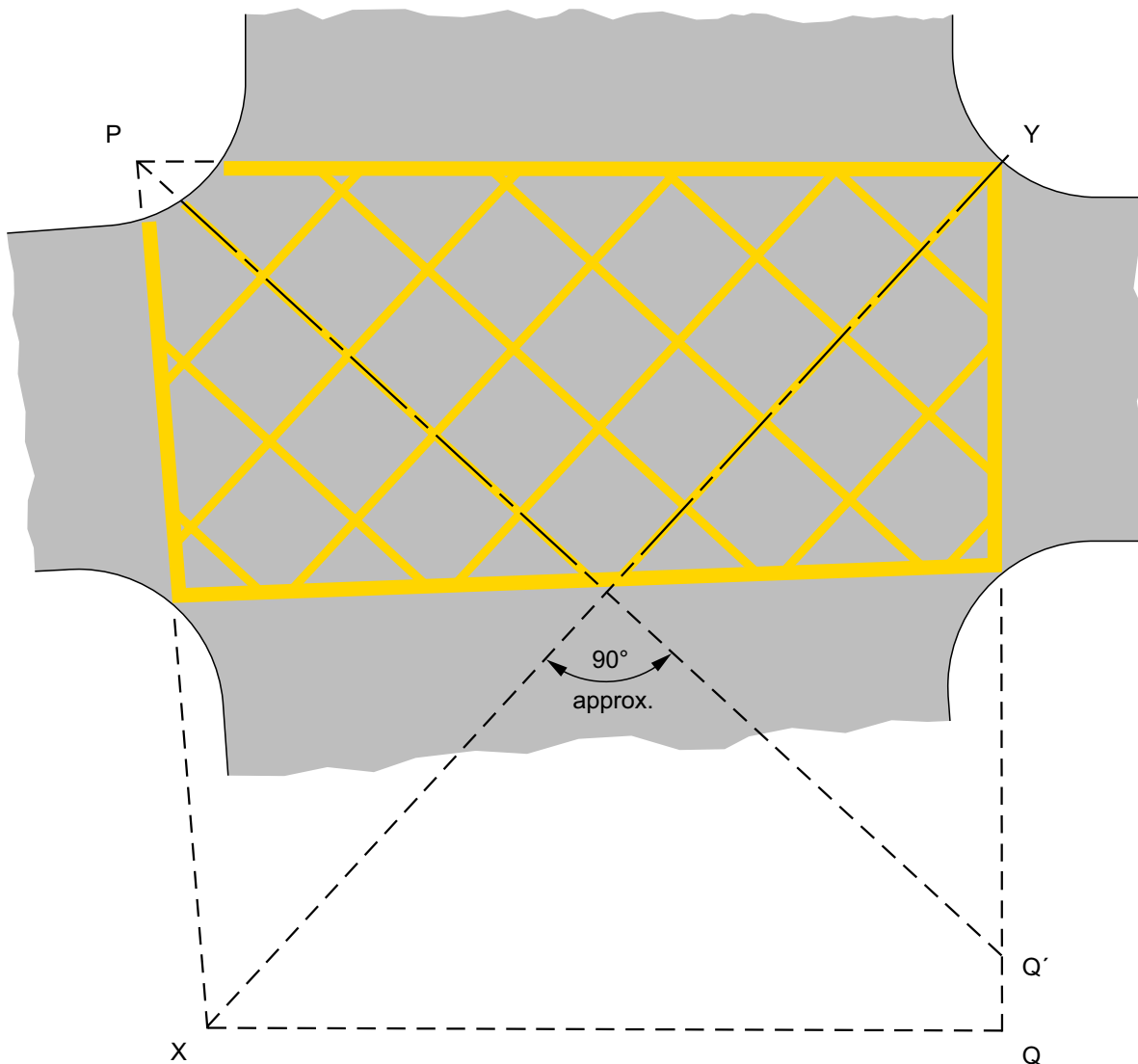

Figure 8-6 Method of setting out the marking to diagram 1043 at a road junction

8.5 Railway level crossings

8.5.1. Advice should be sought from the Office of Rail and Road or, in Northern Ireland, from the local Rail and Roads authority with regard to the provision of yellow box markings at railway level crossings. The Regulations provide two types of markings as diagrams 1045 and 1045.1 (S9-6-26 and S9-6-27 respectively, see Figure 8-7 and Figure 8-8). The former is for a two-way road and the latter for either a one-way road or one carriageway of a dual carriageway road.

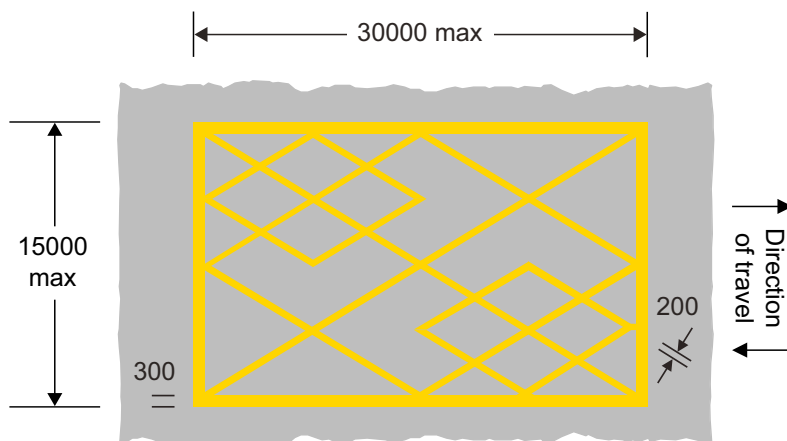

Figure 8-7 Diagram 1045 (S9-6-26)

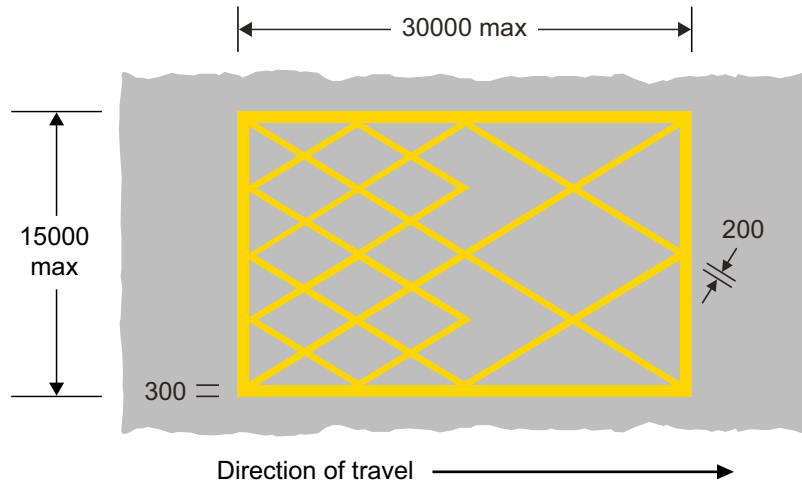

Figure 8-8 Diagram 1045.1 (S9-6-27)

8.5.2. Where a long box is required (up to the 30 m maximum prescribed), the marking should be extended using additional diamond shaped units on the approach side and additional diagonal crosses on the trailing side of the crossing. Part of the diagram 1045 marking may be omitted to accommodate the double white line to diagram 1013.1 version A (see section 3). Parts of both markings may be omitted to accommodate the warning line to diagram 1004 or 1004.1 (see section 2). A warning line is generally used to divide lanes, where traffic is travelling in the same direction and, in the case of diagram 1045, may be used as a centre line where a double white line is not being provided.

9.1 Lane arrows

9.1.1. Direction arrows to diagram 1038 (S11-4-20, see [Figure 9-1](#)) should be used on the approach to busy multi-lane junctions to give drivers advance indication of the correct lane. For use of lane arrows on the major route of a major / minor junction see also section 5, at roundabouts see also 6.7, and at signal-controlled junctions see also Chapter 6. Normally two arrows should be used in sequence in each lane, although sometimes three may be needed. [Table 9-1](#) gives recommended arrow sizes and siting on the approach to a Stop or Give Way line (including signal-controlled junctions and roundabouts). Arrows or destination markings (see [9.2](#) and [9.3](#)) should normally be located at least as far back from the junction as the longest peak hour traffic queue, but not in advance of a previous main junction as this might result in confusion. It can be helpful to locate arrows in conjunction with the advance direction signs.

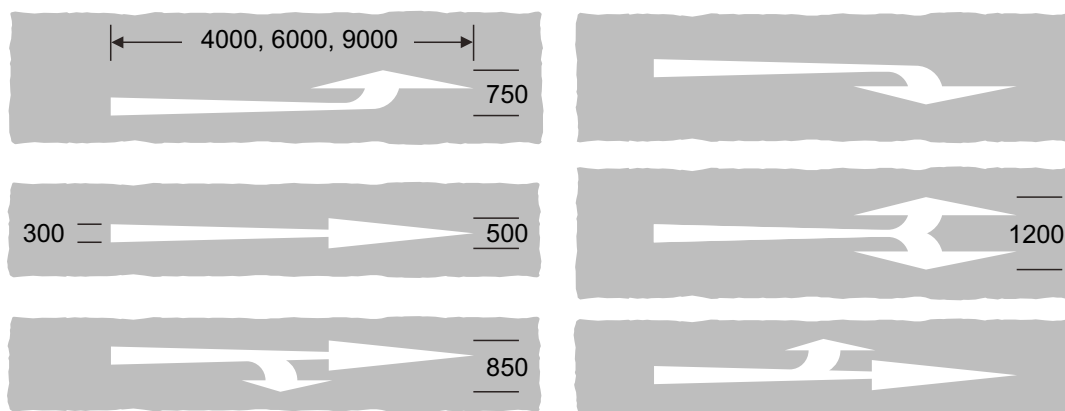

Figure 9-1 Diagram 1038 (S11-4-20) Lane indication arrows (Alternative types)

Table 9-1 Location of lane arrows

Speed limit (mph)	Arrow length (m)	Distance of first arrow from Stop / Give Way (m)	Distance of second arrow from first (m)	Distance of third arrow from second (m)
40 or less	4	15 to 25	30 to 50	30 to 50
50 or 60	6			
70	9	Up to 1.5 times the above distances		

NOTE 1: The greater distances shown for the arrows should be used on roads subject to higher traffic speeds.

NOTE 2: The 9 m arrow is not used with the lane destination markings to diagram 1035 (S11-4-19), and the regulatory markings to diagrams 1036.1, 1036.2 and 1037.1 (S9-6-19 to S9-6-21 respectively; see Chapter 3); in this case, the 6 m arrow should be used on roads with a 70 mph speed limit.

NOTE 3: Where the speed limit is over 40 mph, but traffic speeds are low and the warning line to diagram 1004 (S11-4-2) is used to separate the traffic lanes (see section 2 for further details), the 4 m arrow should be used.

9.1.2. The arrow may indicate one or two directions as shown in diagram 1038. The principal dimensions are indicated in [Figure 9-1](#); full details are shown on the working drawings.

9.1.3. On two-lane approaches to junctions, the arrangement of arrows indicating the lanes for straight ahead, left-turn and right-turn will depend upon the relative traffic volumes making the movements, and on the site conditions. Where there is a heavy right-turn movement, the

right lane should be right-turn only and the nearside lane should be dedicated to the left-turn and ahead movements (or where there is no left-turn, to ahead and right-turn movements, and where there is no ahead direction, to both left and right turns). Similarly where there is a left filter arrow at a traffic signal installation, the filter lane should always be marked with the left arrow marking only, in order to exclude non-filtering traffic. Similar principles should be adopted where there are more than two lanes on an approach. The two-headed arrow may be used in a lane that then widens to two-lanes (e.g. one ahead and one for right-turning traffic), but not where a separate diverge lane is provided. In this case, a bifurcation arrow to diagram 1039 (S11-4-22) should be used at the start of the diverge lane (see 9.6). The lane arrows may be supplemented by a matching indication on an upright sign to diagram 877 (S11-2-22).

9.2 Lane destinations

9.2.1. Worded lane destinations to diagram 1035 (S11-4-19, see [Figure 9-2](#)) reinforcing the information shown on the advance direction signs may be marked on the carriageway on the approach to junctions. They may also be used where there are dedicated lanes within a gyratory system or on the circulatory carriageway of a roundabout (see section 6). The lane destination arrows which form part of diagram 1035 might not always be appropriate and may be omitted (S11-5-45). Where a lane serves more than one exit from the junction, double-headed arrows must not be used as these are not prescribed for this marking; the worded lane destinations should be used either on their own or with an ahead arrow. On the approach to a gyratory system or roundabout with dedicated lanes, it might be more appropriate to use an ahead arrow with the worded destination in each lane.

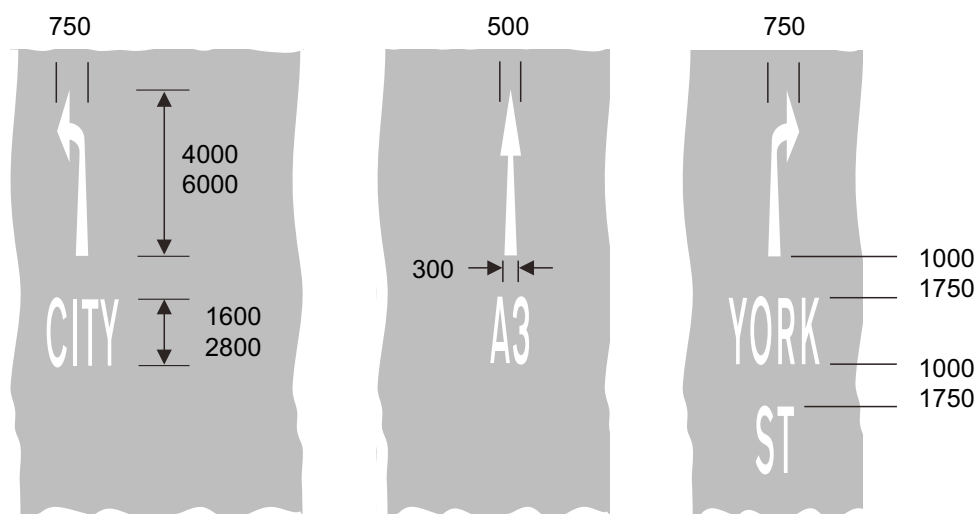

Figure 9-2 Diagram 1035 (S11-4-19) Lane destination markings

9.2.2. In confirming which lane to use, the worded markings provide drivers with an alternative indication to the advance direction sign in the event of it being obscured by high vehicles. Although abbreviations may be used, these must be understandable not only to local drivers, but also to those unfamiliar with the area. Any abbreviations on the upright signs must be recognisable as the same destinations as those on the road, where fewer letters might need to be used. Where an upright sign includes a bracketed route number, that number with or without brackets may be shown on the carriageway; brackets should be included only if there is sufficient width within the lane. If more than one lane serves the same destination, the destination should be placed in each lane that applies and not spread across the lanes.

9.2.3. Two sizes are prescribed for the legend, 1600 mm and 2800 mm; the former is used with the 4 metre arrow and the latter with the 6 metre arrow. The smaller size is intended to be used where the speed limit is 40 mph or less, or where the speed limit is over 40 mph, but traffic

speeds are low and the warning line to diagram 1004 (S11-4-2) is used to separate the traffic lanes (see section 2 for further details). The larger size is used where the speed limit is more than 40 mph and the warning line to diagram 1004.1 (S11-4-3) is used to separate the traffic lanes.

9.2.4. Destinations and direction markings in lanes must match those shown on the relevant upright signs and not contradict them. Failure to do so leads to driver confusion which, in turn, results in lower traffic flows.

9.3 Compulsory turns

9.3.1. For details of the regulatory arrows with the legend “TURN LEFT”, “AHEAD ONLY” and “TURN RIGHT” prescribed respectively as diagrams 1036.1, 1036.2 and 1037.1 (S9-6-19 to S9-6-21) see Chapter 3.

9.4 Guidance arrows

9.4.1. Where considered to be helpful, guidance arrows may be laid within the junction area, although care should be taken that the meaning is clear to drivers on all approaches. Arrows to diagram 1038.1 (S11-4-21, see [Figure 9-3](#)) may be used to indicate a route through a junction, or used in pairs to indicate that opposing right-turning traffic should pass nearside to nearside (see [9.4.2](#)). When used in pairs, a gap of at least one metre should be left between the two arrows as shown in [Figure 9-4](#). Two lengths are prescribed for the arrow, 3025 mm or 4450 mm; normally the larger size will be appropriate, but at very restricted sites it may be necessary to use the smaller arrow. These arrows are identical to those that form part of the mini-roundabout marking to diagram 1003.4 (S9-6-5, see [Figure 6-2](#)) and shown on working drawing P 1003.4 (see [1.10.1](#)).

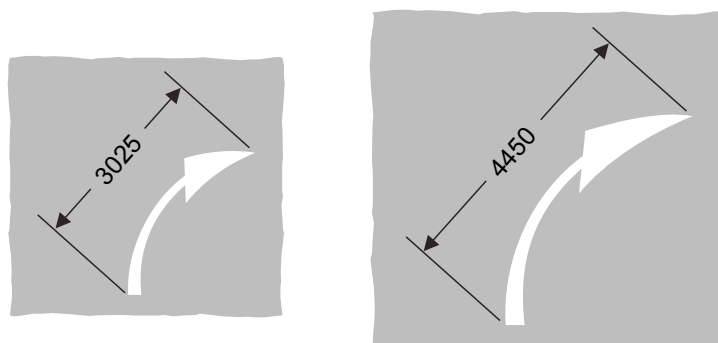

Figure 9-3 Diagram 1038.1 (S11-4-21) Guidance arrows (Alternative sizes)

9.4.2. [Figure 9-4](#) shows the use of a pair of arrows to diagram 1038.1 at a signal-controlled junction that has dedicated right-turn lanes. Use of the arrows to indicate that vehicles should pass nearside to nearside will help prevent conflict, particularly where a signal phase permits opposing right turns at the same time with no ahead movements (see also Chapter 6).

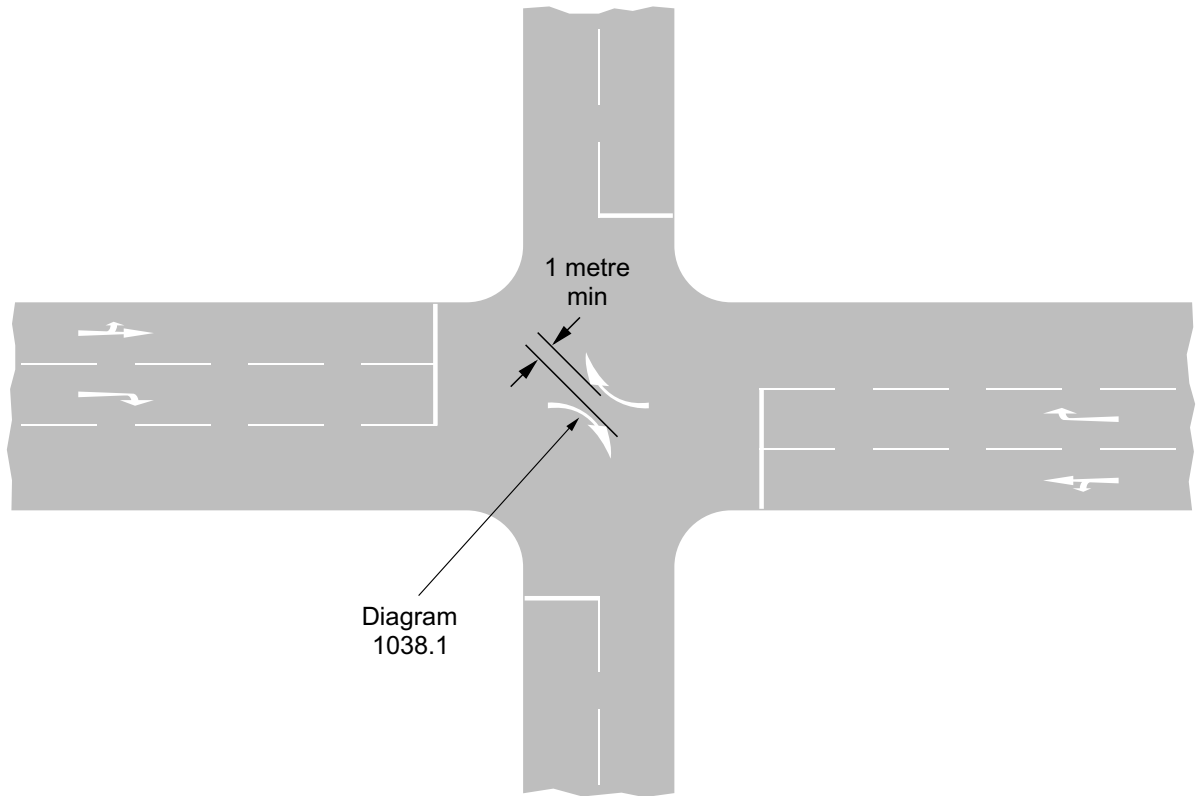

Figure 9-4 Use of guidance arrows at a signal-controlled junction with dedicated right-turn lanes

9.5 Deflection arrows

9.5.1. Deflection arrows to diagram 1014 (S11-4-14, see Figure 9-5) are used to indicate:

- a) the direction in which vehicular traffic should pass a road marking to diagram 1049B or 1049A (cycle lane and bus lane respectively) (S9-6-7 and S9-6-11, see Chapter 3);
- b) the direction in which vehicular traffic should pass a road marking to diagram 1013.1 (S9-6-23; see section 3);
- c) the direction in which vehicular traffic should pass a road marking to diagram 1040, 1040.3 or 1040.4 (S11-4-23 to S11-4-25 respectively; see 2.7.2, 2.7.4, 5.3.8 and 7.2.7, and Table 2-6);
- d) an obstruction on the carriageway ahead;
- e) the reduction in the number of traffic lanes in the carriageway ahead; or
- f) the path to be taken by vehicular traffic to avoid a route available to tramcars only (see Chapter 3).

9.5.2. The arrow may be reversed so that it points to the right in appropriate circumstances.

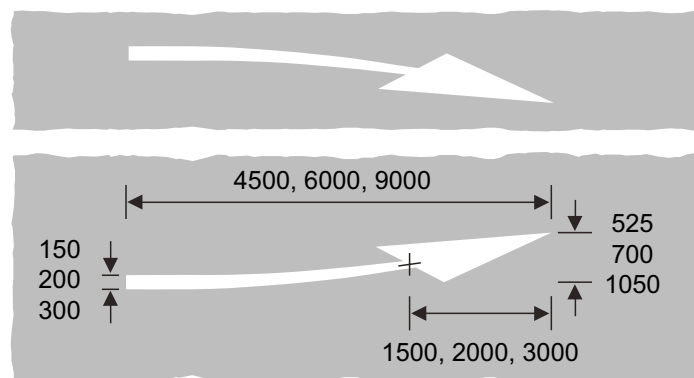

Figure 9-5 Diagram 1014 (S11-4-14) Deflection arrow

9.6 Bifurcation arrows

9.6.1. Markings to diagram 1039 (S11-4-22, see [Figure 9-6](#)) should be provided at the commencement of diverge lanes (other than lane-drops) on the approach to junctions (see sections [7](#) and [10](#)).

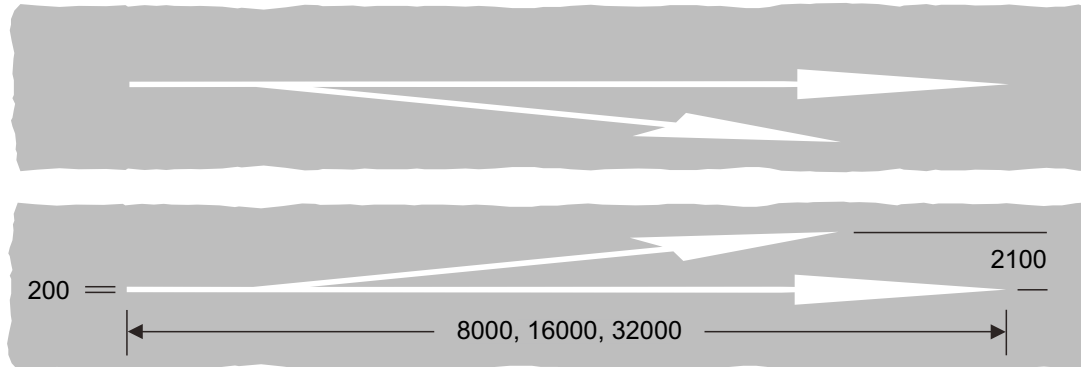

Figure 9-6 Diagram 1039 (S11-4-22) Bifurcation arrow (Alternative sizes)

9.6.2. Bifurcation arrows serve to guide vehicles into the diverge lane at its commencement, ensuring that the full length of the lane is used to slow down for the junction without impeding through vehicles on the main carriageway.

9.6.3. Three sizes are prescribed. The longest (32 m) is for use on motorways or high speed all-purpose dual carriageway roads, the medium (16 m) for use on other roads with a speed limit greater than 40 mph, and the shortest (8 m) elsewhere. It should be noted that the lateral distance between the tips of the arrow heads is 2100 mm for all three sizes of marking. For detailed dimensions, reference should be made to the working drawings (see [1.10.1](#)). The ahead arrow should be laid in the centre of the ahead lane; the turning arrow will then just encroach into the diverge lane.

9.6.4. The arrow marking may be reversed to suit right-turn movements into diverge lanes in the central reservation of dual carriageways and dedicated right-turn lanes on other roads. A double-headed arrow to diagram 1038 (S11-4-20) must not be used in place of diagram 1039 (see also [9.1.3](#)).

9.6.5. [Figure 9-7](#) indicates the location of the 32 m long arrow in relation to other markings. This may be used as a guide for other sizes of arrows; the aim should be to site the arrow shortly after the commencement of the diverge lane, at a point where it has developed adequate width to accommodate the marking without the inclined arrow-head being too close (e.g. less than 750 mm) to the far side of the lane.

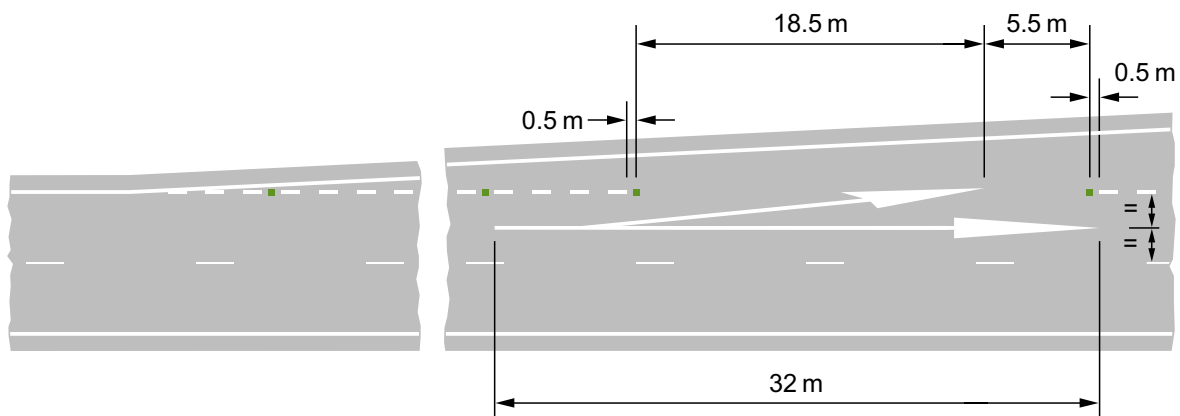

■ Green uni-directional reflecting road stud. Red, white and amber/red studs omitted for clarity.

Figure 9-7 Location of bifurcation arrow

10.1 Introduction

10.1.1. This section is not intended to be a detailed description of traffic calming techniques, but a guide to the markings used with such schemes.

10.1.2. Advice on marking the following is provided in this section:

- a) road humps (other than humped crossings)
- b) build-outs,
- c) chicanes and pinch points, and
- d) gateways.

10.1.3. Guidance on traffic calming within 20 mph zones can be found in Chapter 3. In these zones, road markings are not required on road humps, speed cushions or thumps; however they may be used if the traffic authority considers them appropriate. General guidance on traffic calming is provided in LTN 1/07 ‘Traffic Calming’.

10.2 Markings on road humps

10.2.1. Road hump profiles will generally be either round or flat-topped with ramps. **Figure 10-1** shows a typical layout of markings on a round hump, and **Figure 10-2** on a road hump with tapered ends. **Figure 10-3** indicates the markings used on flat-topped humps. Tapered ends are not used at flat-topped humps where these are provided to help pedestrians cross the road.

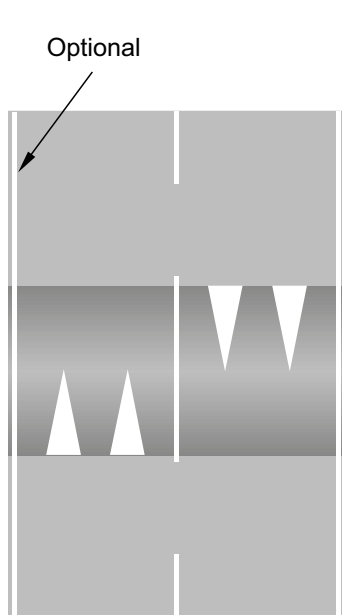

Figure 10-1 Round hump

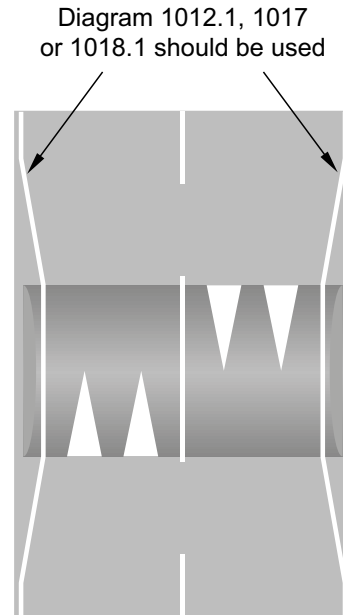

Figure 10-2 Hump with tapered ends

10.2.2. The triangular marking to diagram 1062 (S11-4-33, see **Figure 10-4**) is used on the approach side of a hump. It should extend from the edge of the hump to the highest point (or for a maximum distance of 1850 mm if this is less). On flat-topped humps, the triangle marking should extend for the length of the ramp, if this is less than 1850 mm. Two triangular marks should be used in each lane; in one-way roads they should be placed only on the approach side of a road hump.

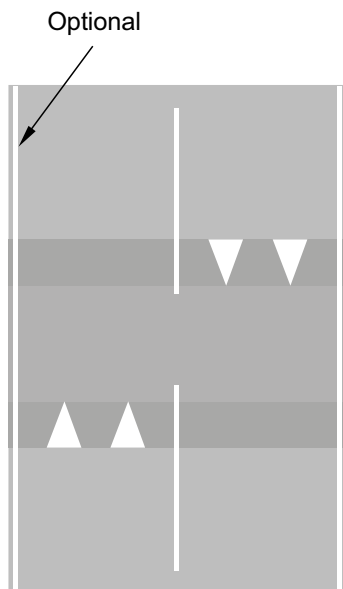

Figure 10-3 Flat-topped hump

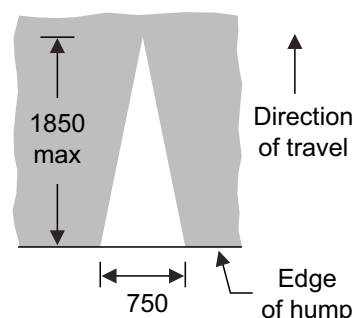

Figure 10-4 Diagram 1062 (S11-4-33)

10.2.3. The top of the hump that is 5 m or more in width should normally be marked with a warning line to diagram 1004 (see section 2). This should be used on the approach to as well as over a hump, to separate the opposing flows of traffic in a two-way road. Where more than one lane is available to traffic proceeding in the same direction in either a one-way or a two-way road, the lanes should be separated by the marking to diagram 1004, and two triangular markings to diagram 1062 should be used in each lane. Care should be taken to ensure that it is evident which line marks the division between opposing streams of traffic, e.g. by widening the centre line marking to 150 mm.

10.2.4. Where a road hump has tapered ends which terminate within 300 mm of the kerb, edge line markings to diagram 1012.1 (see section 2) or, where there are waiting restrictions, yellow lines to diagram 1017 or 1018.1 (see Chapter 3) are used, deflected over the hump to guide vehicles away from the taper. These should normally extend at least 6 m beyond the hump.

10.2.5. In some cases it might prove helpful to provide a cycle lane by-pass between the kerb and the taper of a road hump. Where possible this should be in the form of a mandatory cycle lane, so that other vehicles do not enter the area. The width of the cycle lane should be between 750 mm and 1000 mm. Details of upright signs and road markings for cycle facilities can be found in Chapter 3.

10.3 Markings on speed cushions

10.3.1. A speed cushion is a form of road hump occupying only part of the traffic lane in which it is installed (see [Figure 10-5](#)).

10.3.2. A single triangular marking to diagram 1062 should be used on the approach ramp of each cushion. Where vehicles from both directions might be driven over the same cushion, the triangular marking should be used on both approach ramps.

10.3.3. There is no marking prescribed for delineating the edges of a speed cushion as a warning to pedestrians. It is recommended that cushions be constructed in material which contrasts with the road surface.

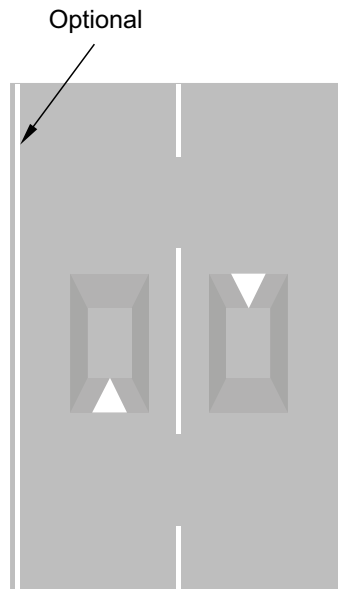

Figure 10-5 Speed cushion

10.4 Markings on thermoplastic humps

10.4.1. A thermoplastic hump or “thump” is a road hump and which is between 900 and 1500 mm long (in the direction of travel), a maximum of 35 mm high and formed of thermoplastic. No markings are necessary if it is constructed from yellow reflective material. Where non-reflective material is used, it should not be coloured yellow, but should normally incorporate four (with a minimum of two) markings to diagram 1062 on each side of the thump in line with the approach lane. The markings should extend from the edge to the top of the thump and, in a one-way road, they should be applied across the full width of the carriageway. Edge of carriageway markings may be continued over the thump if desired.

10.5 Build-outs

10.5.1. A build-out is a feature that extends into the carriageway on one side of the road only. It may be constructed integrally with the footway, or a gap may be left for drainage, or for cyclists where it is considered that they would be at risk of being squeezed by passing vehicles. The approach to a build-out should normally be marked using diagram 1040.4 (S11-4-25), with the taper specified in [Table 2-7](#). Where there is parking immediately preceding the taper, the markings described in [10.5.3](#) may be used. An edge line to diagram 1012.1 (S11-4-11) may be added. Any yellow waiting restriction lines should follow the line of the kerbs around the build-out and not be stopped either side of a chicane or pinch point.

10.5.2. If it is intended to assign priority to traffic from one direction, Give Way and triangular markings (diagrams 1003A and 1023A; S9-6-3 and S9-6-4 respectively) may be provided, supplemented if required by upright signs to diagrams 615 and 811A (S3-2-9 and S11-2-1 respectively; see Chapter 3). Note that it is not lawful to require traffic from both directions to give way. The build-out is normally used on the side of the carriageway leading into a traffic-calmed section and priority given to vehicles travelling in the opposite direction. The Office of Rail and Road or, in Northern Ireland, from the local Rail and Roads authority, should be consulted at an early stage if such an installation is planned near a level crossing.

10.5.3. A series of build-outs along one side of a road can be used to provide sheltered parking places. Projecting the build-out beyond parked cars also enables pedestrians waiting to cross to see and be seen. Diagram 1010 (S11-4-10) should be used to delineate the edge of the carriageway available for through traffic unless the parking is controlled by a Traffic Regulation Order, in which case the appropriate bay marking is used (see Chapter 3).

10.5.4. For details of a build-out that has been provided with a cycle by-pass, see Chapter 3.

10.6 Chicanes and pinch points

10.6.1. A chicane is a narrowing of the carriageway formed by locating build-outs alternately on each side of the road. Pinch points are formed by the construction of build-outs opposite one another; they may be useful at crossing places for pedestrians, whether controlled or not, to reduce the width of carriageway to be crossed. The approaches to chicanes and pinch points should be marked using diagram 1040.4 (S11-4-25) with the tapers specified in [Table 2-7](#).

10.6.2. A centre line road marking to diagram 1004 (S11-4-2) should not normally be used between the build-outs of a chicane or pinch point unless the width of each traffic lane so formed would be 3 m or more.

10.6.3. Any yellow waiting restriction lines should follow the line of the kerb around the build-out (see [10.5.1](#)).

10.6.4. Chicanes are not normally appropriate places for pedestrians to cross the road as the attention of drivers is likely to be concentrated on negotiating the features. Pedestrians should not therefore be encouraged to cross at such locations, whether by the installation of formal crossings or dropped kerbs. If, however, pedestrians are likely to cross at a chicane, the design should ensure that they can be seen clearly and that they can cross the road safely.

10.7 Gateways

10.7.1. Gateways can be provided to indicate places where the road changes in character, e.g. where a rural road enters a town or village. They must not prevent the passage of any vehicle unless there is an appropriate Traffic Regulation Order.

10.7.2. Edge lines and hatched markings can be used to make the carriageway appear narrower than it is, whilst still allowing larger vehicles to overrun these areas if necessary. The effect will be increased if a central refuge island is provided together with hatched markings, but care must be taken not to increase hazards to cyclists. In rural areas, the width of some farm vehicles needs to be considered and care should be taken not to prevent these or other wide vehicles from passing. If there is insufficient space to accommodate a physical island, a ghost island formed by markings alone can be helpful. Central refuge islands should not be provided on roads subject to the national speed limit for reasons of safety.

10.7.3. Edge lines and hatched markings should have a taper in accordance with [Table 2-7](#).

11.1 General

11.1.1. This section contains guidance on the use of the following markings:

- a) SLOW (other than the cycle marking) (see 11.2)
- b) HIGH VEHICLES (see 11.3)
- c) KEEP CLEAR (see 11.4)
- d) LOOK LEFT / RIGHT (see 11.5)
- e) vehicle separation markings (see 11.6)

11.1.2. For guidance on “NO ENTRY” and “PLAY STREET” markings and the “SLOW” cycle marking, see Chapter 3. Guidance on the formation of words, including the elongation of characters can be found in 11.7.

11.2 Slow marking

11.2.1. The Regulations prescribe the word “SLOW” for use on the carriageway as diagram 1024 (S11-4-15, see Figure 11-1). It is prescribed in two sizes; 1600 mm intended for use where the speed limit is 40 mph or less, and 2800 mm where the speed limit is greater than 40 mph. The smaller sizes, prescribed as diagram 1058.1 (S11-4-31) are for use with cycle facilities (see Chapter 3).

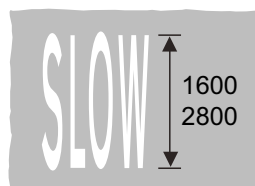

Figure 11-1 Diagram 1024 (S11-4-15)

11.2.2. Although the marking may be used alone, it is most effective when it complements a warning sign so that drivers are told why they need to slow down. The marking may be used with advance signs giving warning of STOP and GIVE WAY but not to supplement the GIVE WAY sign itself, for which the triangle marking to diagram 1023 (S9-6-4) is prescribed (see Chapter 3).

11.2.3. Discretion should be exercised in the use of the marking to ensure that its impact is not reduced through proliferation. At particularly hazardous situations, e.g. on the approach to a bend at the end of a long straight section of high speed road, the marking may be repeated to give added emphasis.

11.3 High vehicle markings at arch bridges

11.3.1. All bridges with a headroom of less than 16' 6" should be clearly signed (see Chapter 4 for the signing of arch bridges). Road markings, together with appropriate warning signs, can be used in the case of arch bridges to guide higher vehicles to the centre of the road, where the clearance may be greater than at the outside edges.

11.3.2. The “HIGH VEHS” road marking to diagram 1024.1 (S2-4-4, see Figure 11-2) is prescribed for use at arch bridges; the arrow that forms part of the marking is identical in shape to diagram 1014 (S11-4-14). High vehicles should be guided through the highest part of the arch

using this marking, together with edge of carriageway markings to diagram 1010 (S11-4-10). These should be aligned with the chord marking on the bridge which indicates the available headroom in the central part of the road (see Chapter 4). The lane or lanes passing under the bridge, together with edge lines, should be extended beyond the bridge for approximately 20 m to encourage long vehicles following the taper of the edge line to manoeuvre under the highest part of the structure and run straight until completely clear of it. In practice, site conditions may prevent the full lengths of markings being used but it should be the aim to provide as nearly as possible the full length indicated in **Figure 11-2**. Where the carriageway is sufficiently wide to permit two-way flow of low vehicles, the centre line should be continued through the bridge as a warning line (see section 2); if there is insufficient width the line should be discontinued.

11.3.3. The area between the edge lines and the edge of carriageway must not be filled in with hatched lines. If all vehicles are required to adopt the centre path route, hatched markings to diagram 1040.4 (S11-4-25) should be used in place of diagram 1010.

11.3.4. If high vehicles are guided to the middle of a road on which a double white line system is in use, the double white lines must be discontinued under the bridge and replaced by a warning line, so that drivers of high vehicles do not commit an offence by crossing the marking to gain access to the highest part of the bridge.

11.3.5. A priority system using Give Way lines to diagram 1003 (see Chapter 3) or shuttle working signals may be used, in which case the carriageway may be reduced to a single lane under the bridge. In addition to guiding high vehicles through the highest point of the arch and thereby reducing the risk of bridge strikes, this may also permit the provision of a new footway or the widening of an existing one under the bridge.

11.3.6. Details of the size and layout of the markings are shown in **Table 11-1**.

Table 11-1 Details of HIGH VEHS marking

Speed limit (mph)	Width of diagram 1010 marking	Taper of diagram 1010 marking	Length of arrow (mm)	Size of HIGH VEHS marking	Gap between legend / legend or legend / arrow
40 or less	100	1 in 40	4500	1600	1000
50 or 60	150	1 in 50	6000	2800	1750

11.4 Keep clear markings

11.4.1. Keep clear markings to indicate areas of the carriageway that should be kept clear of stationary vehicles are prescribed in three forms:

- a) diagram 1026 (S11-4-16), to allow the passage of vehicles into or out of a side road or access (see **11.4.2** to **11.4.4** and **Figure 11-3**),
- b) diagram 1026.1 (S11-4-17), to keep accesses and dropped kerbs clear (see **11.4.5** to **11.4.8** and **Figure 11-4**), and
- c) diagram 1027.1 (S7-4-10), to keep clear the access to a school, hospital or fire, police or ambulance station (see Chapter 3).

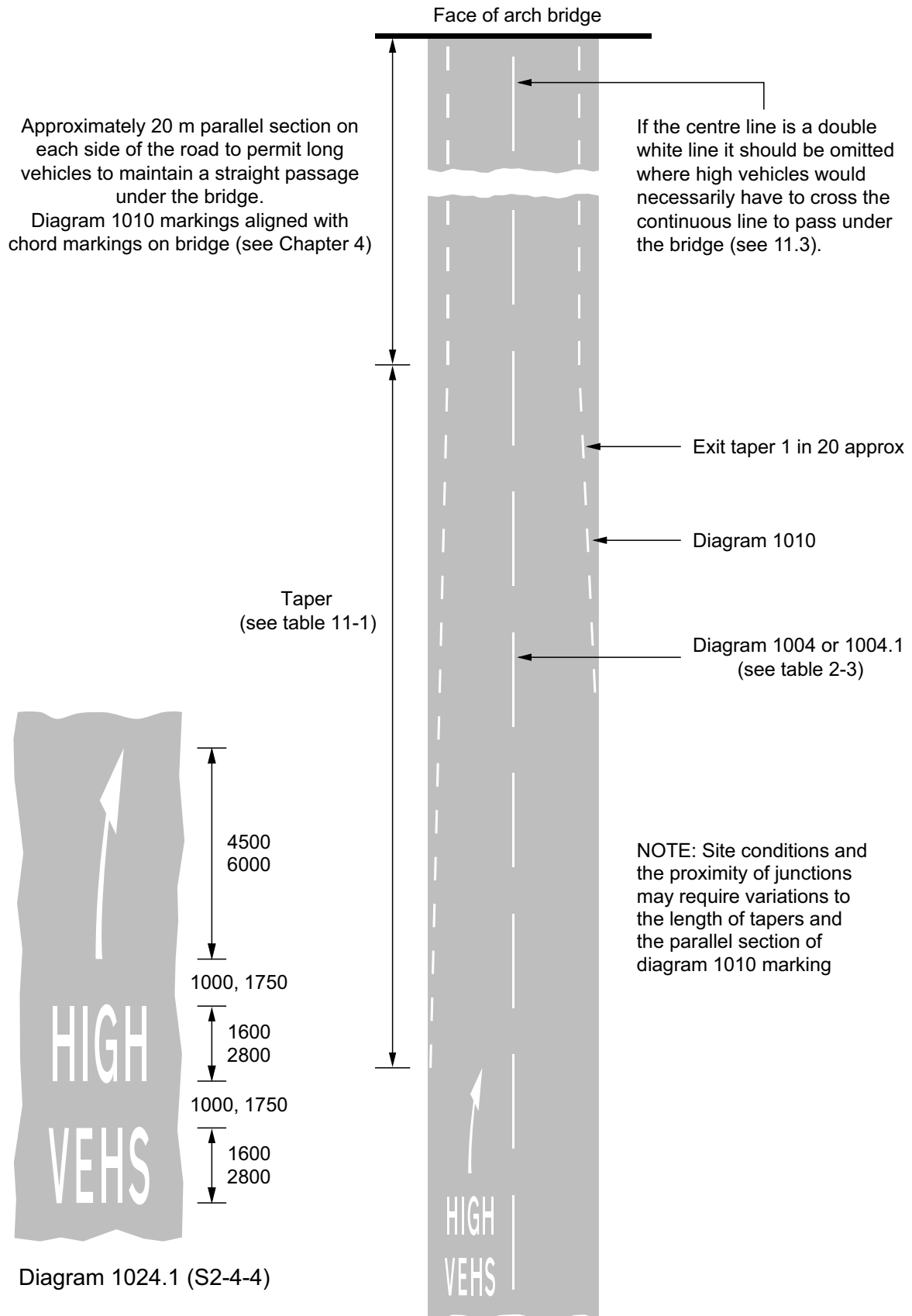

Figure 11-2 Road markings indicating path to be taken by high vehicles under a low bridge

11.4.2. The advisory marking to diagram 1026 (see [Figure 11-3](#)) is used mainly in urban areas where a queue of vehicles waiting at one junction blocks back across another, thereby obstructing the flow of cross traffic. It may also be used at a private entrance used by the general public, but only in places where it can genuinely be helpful in maintaining smooth traffic flow. It is not intended to keep areas of carriageway outside premises clear of parked vehicles.

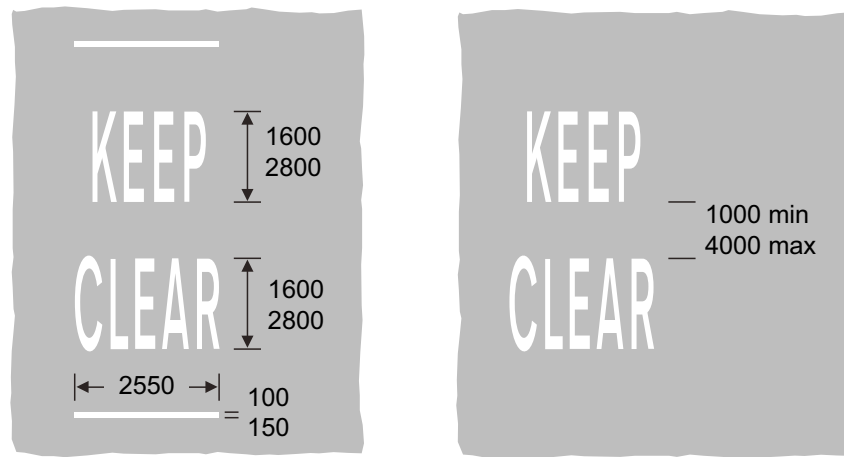

Figure 11-3 Diagram 1026 (S11-4-16) (Alternative types)

11.4.3. The marking is prescribed in two sizes, the larger for use at particularly wide junctions or on multi-lane approaches. It is always coloured white.

11.4.4. The Regulations prescribe transverse lines to indicate the extent of the area to be kept clear of queuing vehicles where this is not obvious. They may be omitted if considered unnecessary, or if proximity to other markings or to traffic signals might cause confusion. The lines, if used, must be 2550 mm long. Lines longer than prescribed must not be used; this can give the impression to side road traffic that vehicles on the main road are required to stop. The words “KEEP CLEAR” must not be turned through 90° and laid parallel to the edge of the carriageway, even across private accesses, where the marking to diagram 1026.1 (see 11.4.5 to 11.4.8) should be considered as an alternative to diagram 1026.

11.4.5. The marking to diagram 1026.1 (see Figure 11-4) may be laid on part of the carriageway which should be kept clear of parked vehicles either outside an entrance to off-street premises, or where the kerb is dropped to provide a convenient crossing place for pedestrians. The marking must not be varied to include the words “KEEP CLEAR” as this is not prescribed by the Regulations.

11.4.6. The width of the marking should normally be 75 mm for speed limits up to 40 mph and 100 mm when the limit is higher. The 50 mm width may be used in environmentally sensitive areas.

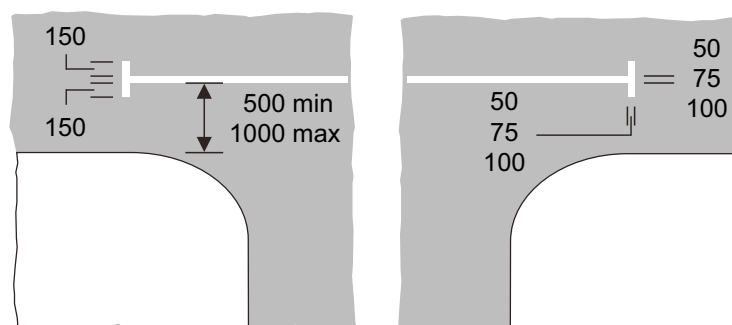

Figure 11-4 Diagram 1026.1 (S11-4-17)

11.4.7. The marking is not legally enforceable. However, if used sparingly it may be helpful in discouraging inconsiderate parking, particularly where a problem is isolated and a Traffic Regulation Order could not be justified or easily enforced. It may be used to mark the gaps across driveways between the ends of separate parking or loading bays, even within a controlled parking zones where it is no longer a regulatory requirement to mark a yellow line where entrance to or exit from the road is made (see Chapter 3). This should reduce the risk of obstruction by non-residents, avoiding the need to provide waiting restrictions that would

prevent residents from parking across their own driveways. The marking may be used across a private entrance where there is a single yellow line, to keep the entrance clear at times when the restrictions are not in force; it should be laid on the carriageway side of the yellow line.

11.4.8. Where two or more closely spaced driveways are to be protected, it will be necessary to consider the distance between the markings to ensure it will accommodate at least one vehicle. An excessively long marking, or over-provision of markings will bring them into disrepute and compromise their effectiveness. The marking should not extend more than 1 m either side of the dropped kerb.

11.5 Look left / look right

11.5.1. Markings to diagram 1029 (S11-4-18, see [Figure 11-5](#)) may be used at any point where pedestrians cross traffic approaching from an unexpected direction. This would include for example a pedestrian refuge in a one-way street, a channelising island where traffic in one direction passes on both sides, and places where pedestrians cross a contraflow bus lane. They may also be used at Zebra, Parallel, Puffin or Toucan crossings and anywhere else it is considered that pedestrians need to be reminded of the direction of traffic flow.

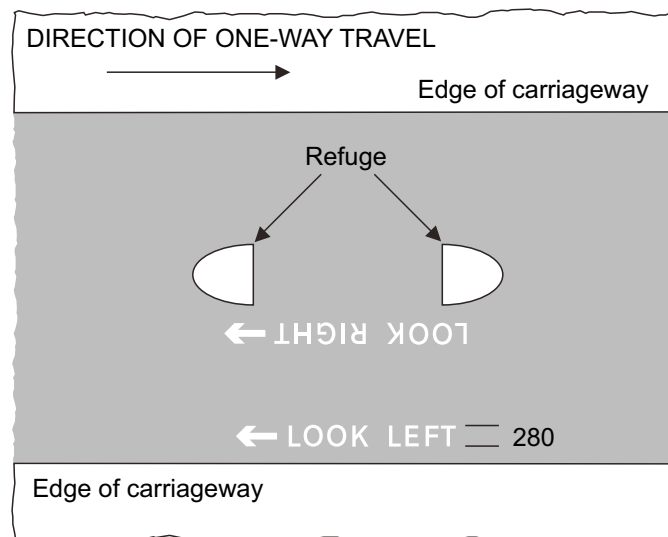

Figure 11-5 Diagram 1029 (S11-4-18)

11.5.2. The marking should never be used in a two-way street unless there is a central pedestrian refuge, otherwise pedestrians will be misled into looking in the wrong direction once half way across.

11.5.3. One size of marking is prescribed, being 280 mm in height using the non-elongated alphabet in S17-6. It should be laid at a minimum distance of 150 mm from the edge of the carriageway. It should not replace or be superimposed upon any yellow line marking indicating waiting restrictions. The arrow is an integral part of the marking and must not be omitted.

11.6 Vehicle separation markings

11.6.1. The chevron markings to diagram 1064 (S11-4-34, see [Figure 11-6](#)) were originally prescribed for use on motorways only. However, the marking may now be used on all-purpose roads, but should normally be confined to dual carriageways with grade separated junctions that are subject to the national speed limit of 70 mph and which comply with [11.6.5](#).

11.6.2. The marking is intended to remind drivers to keep a safe distance from the vehicle in front and has been shown to be beneficial in reducing accidents. Chevrons are placed at

intervals of 40 m, ensuring that a safe distance is kept between vehicles travelling at 70 mph as long as drivers keep a minimum of two chevrons apart.

11.6.3. The performance of chevrons at very high levels of traffic flow is not known. It is likely that most drivers will reduce their spacing (and ignore the chevrons) as flow levels increase. The average peak hour flow encountered during trials was 4000 vehicles per hour. Caution should therefore be exercised when considering the use of chevrons at sites with higher flow levels.

11.6.4. The marking consists of a series of chevrons, marked in all lanes at the same 40 m spacing, as indicated in **Figure 11-6**. They should be laid over a distance of about 4 km, although this may be varied to between 3 km and 6 km.

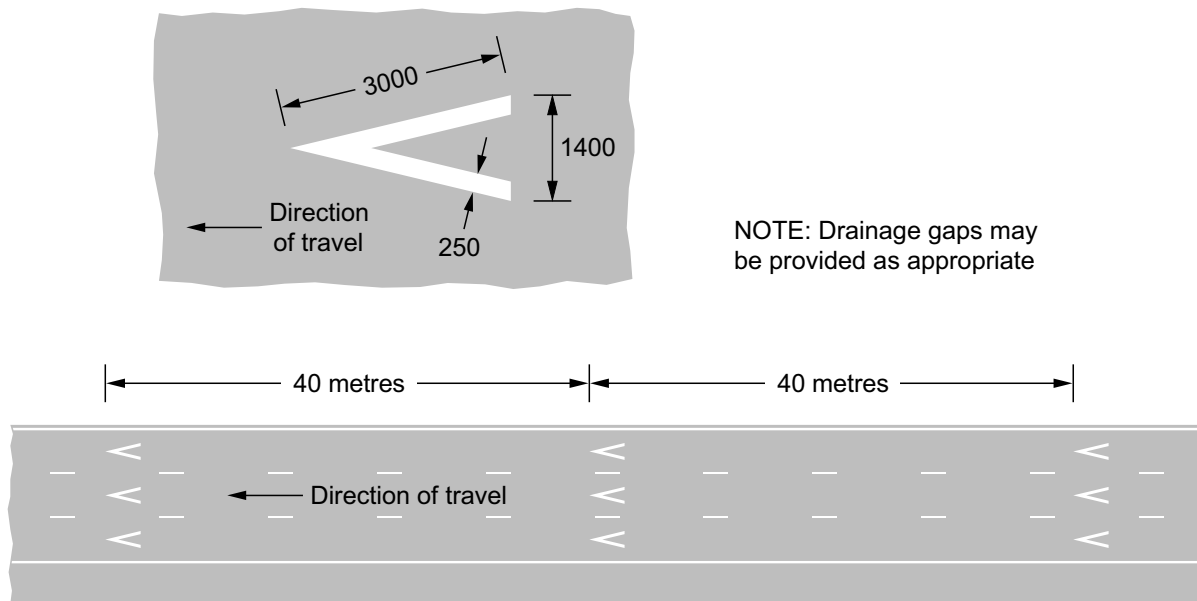

Figure 11-6 Diagram 1064 (S11-4-34)

11.6.5. The distance between successive series of chevrons should generally be between 40 km and 55 km. This need not be complied with rigidly, as specific site criteria are of greater importance. The start of a series of markings should be at least 1.6 km from the end of a previous entry slip road and should terminate at least 3.2 km before the next slip road. Gradients steeper than 3% should generally be avoided.

11.6.6. The upright sign to diagram 2933 (S11-2-50, see **Figure 11-7**) is used with the marking. A minimum of three such signs should normally be used, spaced at about 100 m, 1 km and 2 km after the start of the pattern. A sign to diagram 2934 (S11-2-49, see **Figure 11-8**) with the legend “Check your distance” should normally be provided, and placed about 300 m before the commencement of the markings, with a sign showing the alternative legend “Keep your distance” placed about 300 m after the markings terminate. The upright signs should normally have an x-height of 250 mm on dual two-lane roads (including motorways) with or without hard shoulders and on dual three-lane roads without hard shoulders. On other dual carriageway roads and motorways, the x-height of 300 mm is appropriate. It should be noted that the signs still have a blue background when placed on an all-purpose dual carriageway road.



Figure 11-7 Diagram 2933 (S11-2-50)



Figure 11-8 Diagram 2934 (S11-2-49)

11.7 Formation of words

11.7.1. The basic characters for worded road markings are the capital letters, numerals, brackets, apostrophe and the ampersand from the Transport Medium alphabet, enlarged and where appropriate elongated to two standard sizes (1600 mm and 2800 mm). For details of non-elongated letters see 11.7.7. The alphabets are shown in S17-6 to 8.

11.7.2. To ensure correct letter spacing when forming a word, the characters are placed on imaginary tiles which vary in width according to the size of the character and the tiles butted up to each other to make the legend. The tile width for each elongated letter, other than those in diagrams 1058 and 1058.1 (S11-4-30 and S11-4-31 respectively), is shown in Table 11-2. The distance between the tiles of separate words (e.g. NO ENTRY when marked on a single line) is 400 mm, measured to the edge of the tiles and not to the actual characters.

Table 11-2 Tile widths for elongated characters

Character	Width (mm)	Character	Width (mm)	Character	Width (mm)	Character	Width (mm)
A	544	K	552	U	616	5	488
B	588	L	428	V	520	6	504
C	592	M	736	W	732	7	416
D	616	N	672	X	512	8	520
E	528	O	624	Y	492	9	512
F	476	P	520	Z	476	0	532
G	620	Q	632	1	316	'	156
H	640	R	564	2	480	&	504
I	292	S	548	3	508	(420
J	372	T	436	4	528)	420

NOTE: Table applies to characters 1600 mm and 2800 mm high.

11.7.3. Elongated legends are shown in Table 11-3. These are placed transversely across the carriageway and are elongated in the longitudinal direction, keeping the transverse dimension unchanged. This makes it easier for a driver to read the legend. The table indicates where details of the use of the markings can be found in Chapter 3.

Table 11-3 Elongated legends

Diagram number (TSRGD ref)	Legend
1022 (S9-6-2) ¹	STOP
1024 (S11-4-15)	SLOW
1024.1 (S2-4-4)	HIGH VEHS
1025.1 (S7-4-9) ¹	BUS STOP, BUS STAND
1026 (S11-4-16)	KEEP CLEAR
1035 (S11-4-19)	Lane destinations
1036.1 (S9-6-19) ¹	TURN LEFT
1036.2 (S9-6-20) ¹	AHEAD ONLY
1037.1 (S9-6-21) ¹	TURN RIGHT
1046 (S9-6-17) ¹	NO ENTRY
1046.1 (S9-6-18) ¹	PLAY STREET
1048 (S9-6-14) ¹	BUS LANE
1048.2A (S9-6-16) ¹	TRAM ONLY
1048.5 (S9-6-15) ¹	BUS GATE
1057.1 (S11-4-29)	Cycle route number
1058 (S11-4-30) ^{1, 2}	END (cycle marking)
1058.1 (S11-4-31) ^{1, 2}	SLOW (cycle marking)
1065 (S10-2-9) ^{1, 3}	Speed limit

NOTE 1: See Chapter 3

NOTE 2: Diagrams 1058 and 1058.1 are prescribed in special sizes and may be used only for cycle facilities (see Chapter 3).

NOTE 3: Details of diagram 1065 can be found on working drawing P 1065.

11.7.4. **Figure 11-9** shows how elongation is achieved, using the letter “A” as an example. The base character is taken from the Transport Medium alphabet at an x-height of 400 mm and therefore a capital letter height of 560 mm (see Chapter 7). The letter is drawn on a grid measuring 70 x 70 mm (i.e. 560 / 8). The 1600 mm size character is elongated in the ratio of 200 / 70 and the 2800 mm size in the ratio of 350 / 70. In effect this means that the height of each grid rectangle is one-eighth of the character height.

11.7.5. To set out an elongated worded marking on the carriageway, the following method is suggested:

- a) determine how much of the carriageway width is available for the word, allowing a minimum of 300 mm clear at either side,
- b) decide on the character height required from the appropriate section of this or other chapters,
- c) add up the tile widths from **Table 11-2** to determine the overall width of the word,
- d) if this width is less than that calculated at a) above, then the word may be positioned centrally within the width available,
- e) if the width is more than that calculated at a) above, then a suitable abbreviation will need to be considered where permitted, e.g. for lane destinations. Prescribed markings such as SLOW must not be abbreviated.

11.7.6. Diagrams 1058 (END) and 1058.1 (SLOW) are for use on cycle facilities and are therefore reduced in size (see Chapter 3). The width of the marking (excluding the outside edge of the first and last tiles) is prescribed in the Regulations. These markings do not follow the standard rules for elongation outlined above.

11.7.7. **Table 11-4** lists those worded markings where the letters are not elongated. These markings are generally laid parallel to the edge of the carriageway. The letters are from the Transport Medium alphabet and are shown in S17-6. Various letter heights are prescribed and should be determined from the appropriate section in the relevant chapter. As with elongated words, each letter is placed on an imaginary tile. The width of the tile is determined by looking up the tile width in **Table 11-2** and multiplying this by a factor of actual letter height divided by 560 (e.g. the tile width for the letter “A” with a height of 350 mm is $544 \times [350 / 560] = 340$ mm). The distance between the tiles of separate words (e.g. LOADING ONLY) is determined by multiplying the letter height by a factor of 25 / 56. This is the same as the word spacing used on upright signs (i.e. 2.5 stroke widths; see Chapter 7) and not the same as that used for elongated words where the spacing is equivalent to 4 stroke widths.

Table 11-4 Non-elongated legends

Diagram number (TSRGD ref)	Legend
1027.1 (S7-4-10) ²	SCHOOL KEEP CLEAR, CHILDREN KEEP CLEAR, KEEP CLEAR
1028.2 (S7-4-5) ²	TAXIS, AMBULANCES, POLICE
1028.4 (S7-4-6) ²	DOCTOR, BUSES, CAR CLUB, CYCLE HIRE, DISABLED, ELECTRIC VEHICLES, ELECTRIC VEHS, ELECTRIC MOTORCYCLES, ELECTRIC M/CYCLES, ELECTRIC M/CS, LOADING, LARGE OR SLOW VEHICLES, PERMIT HOLDERS, SOLO MOTORCYCLES, SOLO M/CYCLES, SOLO M/CS (ONLY may follow any of the above)
1028.5 (S7-4-7) ²	TAXIS, AMBULANCES, POLICE
1029 (S11-4-18)	LOOK LEFT, LOOK RIGHT

NOTE 1: Details of the above diagrams can be found on the appropriate working drawings.

NOTE 2: See Chapter 3.

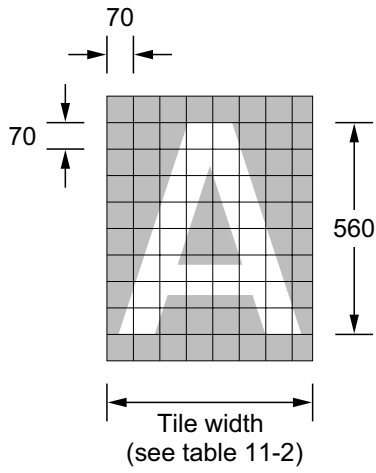

Base character from the Transport Medium alphabet. Capital letter height is 560 mm (equivalent x-height of 400 mm). Tile width is the same as that used on upright signs.

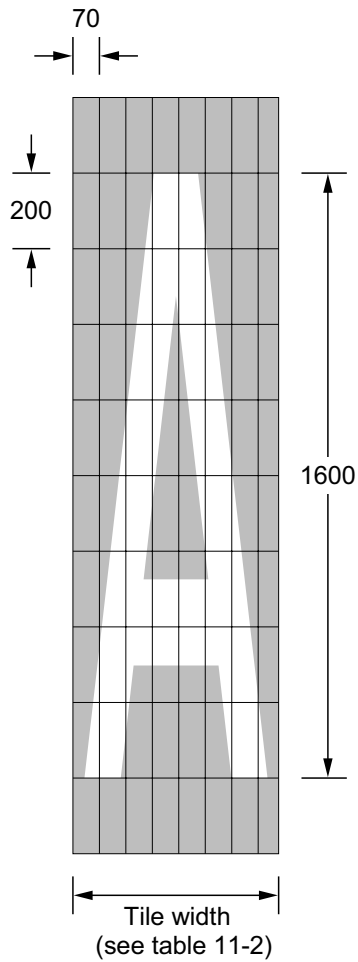
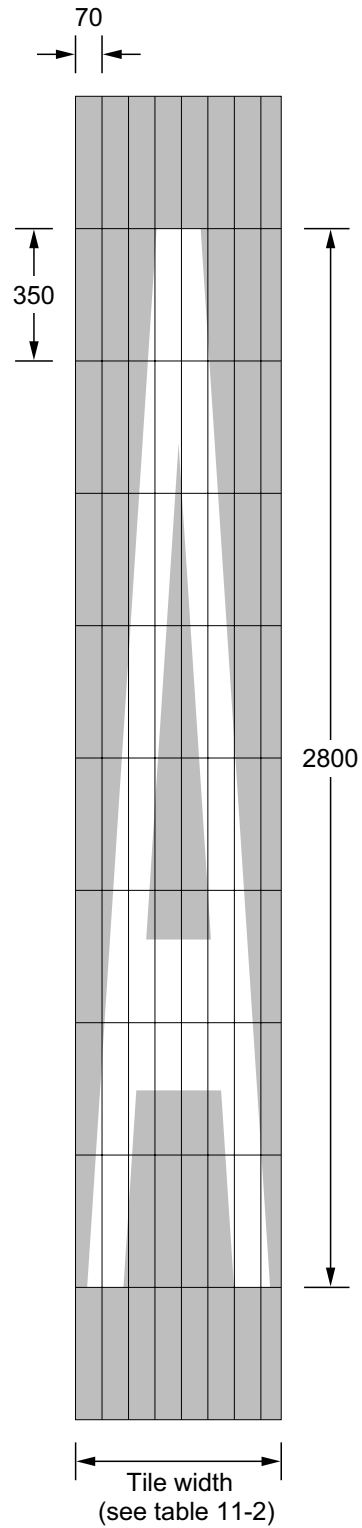

Road markings to S17-7 of the Regulations (base character elongated vertically by a factor of 200/70)

Road markings to S17-8 of the Regulations (base character elongated vertically by a factor of 350/70)

Figure 11-9 Elongation of characters

12.1 General

12.1.1. Road marking materials and road studs are specified in the appropriate British Standards. These are generally the English language versions of standards published by the European Committee for Standardisation (CEN), usually with a national annex specific to the UK.

12.2 Road marking materials

12.2.1. Road markings are applied using thermoplastic, cold plastic, preformed material or paint. They may be laid as permanent markings or as temporary markings at road works.

12.2.2. Thermoplastic material is applied hot and sets on laying. It may be applied by a hand or mechanical applicator. It has good durability and is suitable for use on most roads. Mechanical application is most suitable for use on motorways and other high standard roads where it can be laid in long runs using motorised equipment with minimum disruption to traffic.

12.2.3. Cold plastics are supplied in single or multi-component forms. The product is laid on the carriageway and a cohesive film is formed by chemical action.

12.2.4. Preformed thermoplastic road markings are applied by heating the material until it bonds to the road surface by melting or fusion. They provide a simple way to apply arrows, lettering etc. and to reinstate short lengths of line without the need for substantial application and support equipment.

12.2.5. Preformed cold plastic material is applied to the road surface using an adhesive.

12.2.6. Preformed tape is produced in sheet or roll form and is either bonded to the road surface or inlaid. Pressure is applied, but not heat. Preformed markings have good durability, are of uniform thickness and do not spread in hot weather or under the weight of heavy traffic. They can be difficult to apply to some surface dressings and block paviors. They are also manufactured in an easily removable form for use at road works.

12.2.7. Paint is best restricted to roads where the markings are not subject to heavy traffic wear. It is particularly suitable for edge lining, for yellow waiting restriction lines and for parking bays as, being thinner than thermoplastic material, it will not interfere with drainage. The ease and safety in handling paint compared to thermoplastic material, its suitability for laying with motorised equipment and the material's low initial cost, makes paint an attractive economic proposition for such applications. Acrylic paint is known for its speed of application and the long lengths that can be laid. Combined with its thin application coat, this makes it ideal for "recovery"-type works.

12.3 European and British standards

12.3.1. Initial laboratory requirements for materials are described in BS EN 1790 for preformed markings and BS EN 1871 for directly laid materials. Requirements for drop-on materials (glass beads and anti-skid aggregates) and premix glass beads are dealt with in BS EN 1423 and 1424 respectively. BS EN 1436 specifies several performance levels for properties such as retroreflectivity, skid resistance and durability. Materials will be classified in accordance with the relevant standard following performance testing. In the UK, this will normally be on the basis of laboratory tests to BS EN 1790 or BS EN 1871 as appropriate, and road trials to BS EN 1824.

12.3.2. The Specification for Highway Works (available at www.standardsforhighways.co.uk/mchw/vol1 or from TSO) specifies which performance classes in BS EN 1436 for luminance factor, skid resistance and retroreflectivity are to be used on trunk roads and motorways. As higher retroreflective performance requires additional glass beads, which will reduce the skid resistance, it is not practicable to specify the highest performance class for both. A judgement will need to be made as to which property is more important at any particular location.

12.3.3. Initial performance requirements for road studs are described in BS EN 1463-1 and the specification for road trials in BS EN 1463-2. The performance levels and classes are listed in BS EN 1463-1. Minimum performance levels to be achieved for use on UK roads are specified in direction 7. Guidance on the correct use of road studs is in section 4.

12.3.4. The following British Standards have been withdrawn as a result of the introduction of European standards:

BS 3262: Parts 1, 2 and 3: 1989 Hot applied thermoplastic road marking materials

BS 6044: 1987 Pavement marking paints

BS 6088: 1981 Solid glass beads for use with road marking compounds and for other industrial uses (those sections relating to glass beads for road marking materials)

PD 6518: 1987 Prefabricated temporary road marking materials for use at road works

BS 7396: 1991 Permanent preformed road markings

12.3.5. British Standard BS 7962: 2000 sets out performance requirements for black masking materials. It is not planned to replace this with a European standard.

12.4 Reflectorisation

12.4.1. Road markings fall into two categories, those which must be illuminated with retroreflecting material, and those which may be so illuminated (regulation 9). Markings which must be reflectorised are so indicated in the Schedules in which they are prescribed; they are listed in [Table 12-1](#), along with the relevant chapter where details of the marking can be found. The paragraphs within each Schedule specifying that a marking must be reflectorised are:

S2-7-11

S9-8-13 (S9-8-9 for diagram 1049B; see note 2 in [Table 12-1](#))

S10-3-4

S11-6-7

S14-4-4 (S14-4-5 for the exemption in note 1 in [Table 12-1](#))

12.4.2. It is not usually necessary to reflectorise waiting restriction lines as they do not normally have a guidance function. However, reflectorisation may be advantageous where such lines are used on the rural outskirts of a town and the road edge is not kerbed, where a reflectorised edge of carriageway marking immediately precedes such markings or where they are used on road humps with tapered ends (see section 10 for details of road humps). If the yellow lines are reflectorised, any associated parking bays should be also.

Table 12-1 Markings required to be reflectorised

Diagram number (TSRGD ref)	Relevant Chapter	Diagram number (TSRGD ref)	Relevant Chapter
1001 (14-2-46) ¹	6	1014 (11-4-14)	5
1001.1 (14-2-47) ¹	6	1022 (9-6-2)	3
1001.2 (14-2-48) ¹	6	1023A (9-6-4)	3
1001.2A (14-2-50) ¹	6	1024 (11-4-15)	5
1001.2B (14-2-49) ¹	6	1024.1 (2-4-4)	5
1002.1 (9-6-1)	3	1036.1 (9-6-19)	3 (5)
1003A (9-6-3)	3	1036.2 (9-6-20)	3 (5)
1003.1 (11-4-1)	5	1037.1 (9-6-21)	3 (5)
1003.3 (9-6-6)	5 (3)	1039 (11-4-22)	5
1003.4 (9-6-5)	5 (3)	1040 (11-4-23)	5
1004 (11-4-2)	5	1040.3 (11-4-24)	5
1004.1 (11-4-3)	5	1040.4 (11-4-25)	5
1005 (11-4-4)	5	1040.5 (11-4-26)	5
1005.1 (11-4-5)	5	1041 (11-4-27)	5
1008 (11-4-6)	5	1042 (9-6-22)	5
1008.1 (11-4-7)	5	1046 (9-6-17)	3
1009A (11-4-8)	3, 5	1046.1 (9-6-18)	3
1010 (11-4-10)	5	1049A (9-6-11)	3
1012.1 (11-4-11)	5	1049B (9-6-7) ²	3
1012.2 (11-4-12)	5	1062 (11-4-33)	5
1012.3 (11-4-13)	5	1064 (11-4-34)	5
1013.1 (9-6-23)	5	1065 (10-2-9)	3
1013.5 (9-6-24)	5		

NOTE 1: Except when used in conjunction with diagram 1001.3 (S14-2-51).

NOTE 2: Where indicating the boundary of a mandatory cycle lane (S9-8-9).

12.4.3. Reflectorisation is achieved by adding glass beads to the markings. These reflect light from vehicle headlamps back towards the driver, making the markings much brighter than they would otherwise be. Beads are normally premixed into the material. It is only when some of the material has worn away to expose the beads that they become fully effective; to overcome this, glass beads are also applied to the surface as “drop-on material” as the marking is laid. The retroreflection of a marking in wet conditions can be enhanced by providing a prominent surface texture. This technique, which results in profiled markings, incorporate a series of near-vertical edges which keep the glass beads clear of the water film which would otherwise largely negate the retroreflective property. BS EN 1436 provides specifiers with several classes of wet performance. Profiled markings may be either of the raised rib type prescribed as diagrams 1012.2 and 1012.3 (S11-4-12 and S11-4-13 respectively), or may consist of an embossed pattern in the material. Provided this latter type is no thicker than 6 mm overall, it may be applied to any marking. In the case of raised rib markings, the passage of wheels also generally produces an acoustic or vibratory effect (see 2.6). Improved visibility in all weather conditions may also be achieved by using a wider line where alternatives are prescribed (see 1.7.4 and 1.7.5).

12.5 Statutory colours

12.5.1. The colours white, yellow and red are prescribed for road marking materials.

12.5.2. The colours used for road markings must conform to the chromaticity requirements in BS EN 1436. For comparison, however, the equivalent colours from BS 381C are described below.

12.5.3. The standard colour for waiting and loading restriction road markings is No 355 (Lemon). No 309 (Canary) is also acceptable. However, in environmentally sensitive areas No 310 (Primrose) or No 353 (Deep Cream) may be used. Special authorisation is not necessary for any of these shades. Different shades should not be used on adjacent lines, as in certain conditions the lighter colour may appear white when seen in direct comparison with the standard yellow.

12.5.4. Black material for masking road markings (for example, during road works) must conform to BS 7962:2000 with Amendment No 1, dated 2004, or an equivalent EEA Standard. There is currently no European Standard for this material.

12.5.5. Instead of white road markings, colour-contrasting surfacing, or paving in a different pattern or appearance, may now be used to distinguish parking areas from the surrounding carriageway. More advice is given in Chapter 3.

12.6 Application of markings

12.6.1. As it is not possible to lay in-situ road markings to precise dimensions, and to allow for markings “spreading” in service, some tolerance in the prescribed dimensions is permitted by regulation 7. Specified values may vary by up to 5° for angular measurements and by the tolerances quoted in [Table 12-2](#) for linear dimensions. No tolerance is permitted for those angular or linear dimensions which are expressed as a maximum or minimum value. A tolerance of plus or minus 25 mm is normally allowed in the lateral positioning of lane lines.

Table 12-2 Linear road marking tolerances

Dimension shown in the diagrams	Allowable tolerance
3 m or more	Up to 15% greater than or 10% less than the specified dimension
300 mm or more, but less than 3 m	Up to 20% greater than or 10% less than the specified dimension
Less than 300 mm	Up to 30% greater than or 10% less than the specified dimension

12.6.2. It is essential that all types of marking should be skid resistant in wet conditions. This is particularly important where the camber or cross fall is steep, and at junctions. The Specification for Highway Works requires a skid resistance value of not less than 45 (sub-clause 1212.3), except in certain locations where the designer may select a value of not less than 55 (sub-clause 1212.6). This higher value should be used for yellow bar markings (see [6.10.7](#)) and it would also be appropriate to use it for other markings which might pose a hazard to a braking vehicle.

12.7 Maintenance

12.7.1. Road markings, including reflecting road studs, must be well maintained if they are to fulfil their purpose. Regulatory markings must be maintained properly if they are to be enforced effectively. Guidance can be found in TD 26 in Volume 8 of DMRB and ‘Well-managed Highway Infrastructure: A Code of Practice’ (published by UK Roads Liaison Group).

12.7.2. All markings, including reflecting road studs, should be inspected at regular intervals both by day and, where appropriate, for reflectance by night. Retroreflectivity of road markings can be measured by static equipment or by dynamic equipment mounted on a vehicle travelling at normal traffic speeds.

12.7.3. It is not possible to recommend specific renewal intervals for markings as these will depend upon the type of line, the material comprising the marking and traffic flow. Traffic authorities should keep their carriageway markings under review (particularly on heavily-trafficked roads) to ensure that their effectiveness is maintained at all times.

12.7.4. Markings should be renewed as soon as possible after resurfacing or on the completion of road works which may have damaged them. Where it is not practicable to restore them immediately using permanent materials, a temporary marking should be used, particularly at sites such as road junctions, if the absence of a marking might give rise to dangerous conditions. Arrangements should be made to protect road studs during surface dressing operations.

12.7.5. Where it is not possible to provide temporary road markings, drivers should be warned of their absence by means of advance warning signs. At junctions where all, or any part, of the STOP or Give Way marking has been removed and temporary markings cannot be provided, a sign prescribed by S13-9 with the legend "NO STOP MARKINGS" or "NO GIVE WAY MARKINGS" (white letters on a red background in accordance with S13-9-8) should be placed on the minor road near the junction, preferably about 5-10 m from the edge of the main carriageway. Where road markings associated with a level crossing are absent, the legend "NO ROAD MARKINGS AT LEVEL CROSSING" should be used. Alternative legends "NO ROAD MARKINGS" and "NO ROAD MARKINGS AT JUNCTION" should be used where appropriate. Where lane lines or centre of carriageway lines on inter-urban roads have been removed (especially where there is no street lighting), a sign bearing the legend "NO ROAD MARKINGS FOR [numeral] MILES" or "[numeral] YARDS" or, if appropriate, "NO ROAD STUDS FOR [numeral] MILES" or "[numeral] YARDS" should be used with the appropriate distance inserted in accordance with S18-3-4, S18-3-5 and S18-3-6(b).

12.7.6. All obsolete markings and road stud housings, particularly those which may give a misleading indication, should be removed as soon as possible. This is particularly important where new central refuges are installed; the old centre line and any road studs should always be realigned (see [Table 2-7](#) for recommended tapers) before the road works signing and guarding is removed.

12.8 Drainage

12.8.1. It is essential that road markings should not prevent a carriageway from draining properly. Even a thin film of standing water can be dangerous in the winter, when it may freeze. Markings may project up to 6 mm above the adjacent road surface (regulation 10(1)), although the ribs of raised rib markings and the centre portion of diagrams 1003.4 (S9-6-5) and 1049.1 (S9-6-8) may be higher. In difficult areas, where for instance the cross fall is nearly level, or the road is at the lowest point of a sag curve, it may be preferable to use paint in place of thermoplastic for continuous edge lines, as its negligible thickness will not obstruct the flow of surface water. However, this may not be practicable if the markings will be heavily-trafficked, as paint is generally less durable, and it might be preferable to leave short gaps in the marking to aid drainage.

12.8.2. Generally a drainage channel of 225 mm should be maintained between markings and the kerbed edge of a road. This will allow water to flow freely and help to ensure that the markings do not become unnecessarily dirty.

The Traffic Signs Regulations and General Directions 2016 apply to England, Wales and Scotland, but in Northern Ireland the equivalent legislation is the Traffic Signs Regulations (Northern Ireland) 1997 (“NI Regulations”). In Northern Ireland, references to “Directions” are not applicable; where these are referred to, advice should be sought from the Department for Infrastructure’s headquarters in Belfast.

The following table indicates differences in regulation numbers between the two sets of Regulations where these are relevant to this chapter of the Traffic Signs Manual. The notes below indicate other differences of legislation or practice between Northern Ireland and the rest of the UK.

Table A-1 Legislative differences between Northern Ireland and rest of the UK

TSM 5 ref	Meaning	TSRGD 2016 reference	NI Regulations reference
2.7.1	Proportional dimensions of hatched markings	regulation 7	10(4)
3.1.1	Double white lines; legal requirements and exemptions	S9-7-9 & 10	25
8.1.1	Legal meaning of yellow box	S9-7-11	26
12.6.1	Road marking tolerances	regulation 7	10

In the following notes, paragraph numbers refer to this edition of Chapter 5 of the Traffic Signs Manual.

[1.2.3](#), [3.1.7](#), [8.1.5](#) In Northern Ireland, “Section 36 of the Road Traffic Act 1988” should be replaced with “Article 50 of the Road Traffic (Northern Ireland) Order 1995, as amended by Article 75(1) and item 19 of Schedule 8 to the Road Traffic Regulation (Northern Ireland) Order 1997”.

[2.5](#) In Northern Ireland, policy on the use of edge of carriageway markings and associated road studs is currently being developed. Advice should therefore be sought from the Department for Infrastructure’s headquarters.

[6.10](#) In Northern Ireland, yellow bar markings are prescribed as diagram 1003.6, but only for use at roundabouts on dual carriageway roads. The dimension from the Give Way line to the first bar is prescribed as either 35m or 50m.

[10.2](#) In the Northern Ireland Regulations, markings on humps and cushions are prescribed as composite layouts in diagrams 1060, 1060.1, 1061, 1061.1 and 1062. Elsewhere in the UK, the triangular hump marking is prescribed separately as diagram 1062; it may be used in conjunction with other prescribed markings as appropriate.

LIST OF FIGURES

2-1	Centre lines	11
2-2	Use of warning lines where there is a change of speed limit	13
2-3	Lane lines	14
2-4	Warning lines	16
2-5	Typical road junction	18
2-6	Edge of carriageway lines	19
2-7	Raised profile edge lines	22
2-8	Diagram 1040 (S11-4-23) Hatched markings in the centre of a two-way road (Alternative types)	24
2-9	Diagram 1040.3 (S11-4-24) Loss of right-hand lane on a motorway or dual carriageway road	25
2-10	Diagram 1040.4 (S11-4-25) Area at edge of carriageway which drivers should not enter unless safe to do so	26
2-11	Diagram 1040.5 (S11-4-26) End of hard shoulder	26
2-12	Refuge or central island	27
2-13	Centre of carriageway diagonal hatched marking (parallel version, full width)	28
2-14	Centre of carriageway diagonal hatched marking (parallel version, narrow width)	28
2-15	End of dual carriageway	30
2-16	Diagram 1041 (S11-4-27) Chevron marking which drivers should not enter unless safe to do so (Alternative types)	31
2-17	Diagram 1042 (S9-6-22) Marking which drivers must not enter except in an emergency (Alternative types)	31
2-18	Cross-sections showing layout of road markings on all-purpose roads	32
2-19	Cross-sections showing layout of road markings on motorways	33
3-1	Diagram 1013.1 (S9-6-23)	34
3-2	Warning arrows on approach to double lines on a two-lane carriageway	37
3-3	Warning arrows within a double white line system	37
3-4	Use of deflection arrow at exit from a roundabout	38
3-5	Use of inclined lines at a refuge	38
3-6	Diagram 1013.5 (S9-6-24) (Alternative types)	42
3-7	Road markings for start and end of climbing lane	43
3-8	Layout of markings at a crest	45
3-9	Layout of markings at a crest where carriageway width is unchanged	45
5-1	Simple T-junction	50
5-2	Other types of T-junction	51
5-3	Simple crossroads	51
5-4	Ghost island junction	53
5-5	Right / left staggered ghost island junction	55
5-6	Left / right staggered ghost island junction	55
5-7	Use of double white lines to discourage	56
5-8	Uphill approach to right-turn lane	56
5-9	Downhill approach to a right turn	56
5-10	Crossroads with ghost islands	57
5-11	Dual carriageway junction	58
5-12	Single lane dualling	60
6-1	Conventional roundabout	62
6-2	Diagram 1003.4 (S9-6-5) Mini-roundabouts (Alternative sizes)	63

6-3	Options for marking approaches to mini-roundabouts	64
6-4	Contiguous double mini-roundabout	65
6-5	Double mini-roundabouts with short central link	66
6-6	Roundabout with lane guidance (“kick”) markings to diagram 1005 (S11-4-4)	68
6-7	Example of a segregated left-turn lane	70
6-8	Diagram 1067 (S11-4-35)	72
6-9	Example of a special layout of a roundabout	74
7-1	Simple taper merge and diverge	76
7-2	Ghost island merge from a two-lane slip road (urban roads only)	79
7-3	Single lane merge	79
7-4	Two lane-gains from a two-lane slip road	80
7-5	Taper merge followed by lane-gain	81
7-6	Lane-gain followed by taper merge	81
7-7	Lane-drop	82
7-8	Ghost island diverge with lane-drop and taper diverge	84
7-9	Ghost island diverge with double taper diverge	85
7-10	Taper merge with auxiliary lane	87
8-1	Diagram 1043 (S9-6-25) Yellow box marking which extends across the full width of the carriageway at a road junction (other than at a gyratory system or roundabout)	91
8-2	Diagram 1043 (S9-6-25) Yellow box marking which extends across part of the width of the carriageway at a road junction (other than at a gyratory system or roundabout) (variant)	91
8-3	Diagram 1043 (S9-6-25) Yellow box junction marking on an area of carriageway at a gyratory system or roundabout where entry of traffic into that area is at all times controlled by traffic light signals (variant)	92
8-4	Diagram 1043 (S9-6-25) Yellow box marking at a road narrowing (variant)	93
8-5	Tramway crossing a yellow box	93
8-6	Method of setting out the marking to diagram 1043 at a road junction	95
8-7	Diagram 1045 (S9-6-26)	95
8-8	Diagram 1045.1 (S9-6-27)	96
9-1	Diagram 1038 (S11-4-20) Lane indication arrows (Alternative types)	97
9-2	Diagram 1035 (S11-4-19) Lane destination markings	98
9-3	Diagram 1038.1 (S11-4-21) Guidance arrows (Alternative sizes)	99
9-4	Use of guidance arrows at a signal-controlled junction with dedicated right-turn lanes	100
9-5	Diagram 1014 (S11-4-14) Deflection arrow	100
9-6	Diagram 1039 (S11-4-22) Bifurcation arrow (Alternative sizes)	101
9-7	Location of bifurcation arrow	101
10-1	Round hump	102
10-2	Hump with tapered ends	102
10-3	Flat-topped hump	103
10-4	Diagram 1062 (S11-4-33)	103
10-5	Speed cushion	104
11-1	Diagram 1024 (S11-4-15)	106
11-2	Road markings indicating path to be taken by high vehicles under a low bridge	108
11-3	Diagram 1026 (S11-4-16) (Alternative types)	109
11-4	Diagram 1026.1 (S11-4-17)	109
11-5	Diagram 1029 (S11-4-18)	110
11-6	Diagram 1064 (S11-4-34)	111

11-7	Diagram 2933 (S11-2-50)	112
11-8	Diagram 2934 (S11-2-49)	112
11-9	Elongation of characters	115

LIST OF TABLES

2-1	Centre lines on single carriageway roads	12
2-2	Lane lines	15
2-3	Warning lines	17
2-4	Visibility distance	18
2-5	Edge of carriageway markings	20
2-6	Taper and arrow details for diagrams 1040, 1040.3 and 1040.4	24
2-7	Tapers on the approach to refuges	27
3-1	Location of deflection arrows	37
3-2	Visibility distance	39
5-1	Warning lines at major / minor junctions on single carriageway roads	50
6-1	Spacing of bars on main carriageway	73
6-2	Spacing of bars on slip roads	73
7-1	Taper-merge and lane-gain markings	75
7-2	Taper diverge and lane-drop markings	75
7-3	Size of markings in figures 7-1 to 7-12	77
7-4	Taper for slip road lane reduction	78
7-5	Auxiliary lanes and tapers	86
9-1	Location of lane arrows	97
11-1	Details of HIGH VEHS marking	108
11-1	Details of HIGH VEHS marking	107
11-2	Tile widths for elongated characters	112
11-3	Elongated legends	113
11-4	Non-elongated legends	114
12-1	Markings required to be reflectorised	118
12-2	Linear road marking tolerances	119
A-1	Legislative differences between Northern Ireland and rest of the UK	121

abbreviations 1.5.2; 9.2.2; 11.7.5

ADS *see* advance direction signs

advance direction signs 9.2.1; 9.2.2

 arrows 9.1.1

 destinations 9.2.1; 9.2.2

 ghost island 7.5.2; 7.5.3; Fig 7-8; Fig 7-9; 7.6.3

 lane drop 7.4.1; 7.6.3

 segregated lane 6.8.2

advance informatory signs 7.5.2; Fig 7-8; Fig 7-9

“Ahead only” 9.3.1; Table 11-3

alphabet *see* worded markings

amber studs *see* road studs, amber

ambulance station 8.1.1; 8.3.3; 8.4.4; 11.4.1

“Ambulances” Table 11-4

angle of markings 1.6.4

 hatching 8.2.4

 inclined lines 3.6.1; Fig 3-5

 roundabouts 6.5.2; 6.6.8

 splayed 3.5

 stop lines 6.5.2

 taper Table 2-7; Table 7-1; Table 7-2

 yellow bars 6.10.5

 yellow box 8.4.1; 8.4.2; 8.4.4

anti-skid *see* skid resistance

arch bridges *see* bridges

arrows 1.7.4; Table 2-6; **3.4**; 5.4.3; 5.5.1; 6.3.4; 6.7; 7.5.4; **9.1**; Fig 9-1; Table 9-1

 ahead 6.7.2; 6.7.3; 7.3.1; 7.3.4; 9.1.3; 9.2.1

 bifurcation Table 2-6; 2.9.3; 5.3.9; 7.2.4; 7.5.4; Fig 7-8; Fig 7-9; 9.1.3; **9.6**; Fig 9-6; Fig 9-7

 compulsory turns 9.3.1

- deflection 2.7.2; 2.7.4; Fig 2-9; 2.10.3; **3.4**; Fig 3-2; Fig 3-3; Fig 3-4; Table 3-1; 3.7.2; 3.9.1; 5.3.8; 5.3.12; 7.2.7; 7.6.2; Fig 7-10; **9.5**; Fig 9-5
- destinations **6.7**; **9.1**; 9.2.1; 9.2.3
- direction 9.1.1; Fig 9-1
- double-headed 5.3.9; 9.1.3; 9.2.1; 9.6.4
- guidance 9.4; Fig 9-3; Fig 9-4
- high vehicles 11.3.2; Table 11-2
- junctions 5.4.3; 5.5.1; 9.1.1; 9.1.3; 9.4.1; 9.4.2
- lane indication 5.3.9; 6.7.3; 6.8.2; **9.1**; Fig 9-1; Table 9-1
- left turn 6.7.3; 9.1.3
- look left / right Fig 11-5; 11.5.3
- right turn 2.9.3; 5.3.9; 6.7.2; 9.1.3
- roundabouts Fig 3-4; 6.1.6; 6.3.1; 6.3.3; Fig 6-2; 6.3.4; 6.6.7; 6.7.1–6.7.3; 6.8.2
- warning 3.4.1–3.4.3; Fig 3-2; Fig 3-3; 3.6.1; 5.3.12
- auxiliary lane 2.4.1; 7.6; Table 7-5; Fig 7-10; Fig 7-11; Fig 7-12
- bilingual markings 1.10.2
- bollards 1.3.3; 6.3.7
- boundary 2.7.1; 2.7.3; 2.9.3; 3.5.1; 3.10.1
- bus lane 2.11.1
 - chevrons 2.11.2; 2.11.3
 - cycle lane 2.4.1; 2.7.5; 2.11.1; Table 12-1
 - double lines 3.5.1
 - dual carriageway 2.10.2
 - hatching 2.7.1; 2.7.3; 2.7.5; 6.2.2
 - refuge Table 2-5
 - studs 2.10.4; 4.4.1
 - yellow box 8.3.7; 8.3.8; 8.4.1; 8.4.4
- box junction see yellow box
- bridges 1.3.3; Table 2-5; 2.5.10; 11.3; Table 11-1; Fig 11-2
- brow see hills
- build-outs 2.7.5; **10.5**; 10.6.1–10.6.3
- bus lane 2.5.5; Table 2-5; 9.5.1; 11.5.1; Table 11-3
- bus stand see bus stop

bus stop 2.9.4; 4.4.1; 8.3.4; 8.3.5; Table 11-3

calming see traffic calming

“Car club” Table 11-4

carriageway 1.3.2–1.3.3; 2.3.1; Fig 2-18; Fig 2-19; see *also* dual carriageway; edge of carriageway; single carriageway

arrows 3.4.2; Fig 3-2; Fig 3-3; 3.4.4

centre line 2.2; Fig 2-13; Fig 2-14

circulatory 6.2.1; 6.3.1; 6.5.2; 6.6; 6.7.2

double white lines 3.1.1; Fig 3-1; 3.1.4; 3.2.2

dual to single 2.10; 4.1.4

end 2.10; Fig 2-15

junctions 5.4

lanes 2.3.2; Fig 2-3; 2.3.4

two-way 2.4.5

width 3.10.1; 3.11.2; 3.12.1–3.12.2; 3.13.1; Fig 3-9; 5.3.2; 5.3.5; 6.1.3

yellow bars 6.10.1; 6.10.3; 6.10.5; Fig 6-8; 6.10.6; Table 6-1

centre line 1.7.1; 1.7.3; 2.1.1; **2.2**; Fig 2-1; Table 2-1; Fig 2-18

arrows 2.7.2

chicane 10.6.2

hatching 2.7.2

offset 2.2.5; 5.3.5

omission 2.2.6; 2.5.9; Fig 11-2

pinch point 10.6.2

placement 2.2.5; 3.2.2

replacement 2.2.3; 2.4.2; 12.7.6

roundabouts 6.1.3

studs 1.2.4; Table 2-1; Table 2-2; Table 2-3; **3.3**

warning 2.2.3; 2.4.1; 2.4.5; 2.4.14; 6.1.3; 11.3.2; Fig 11-2

width 2.2.2; 2.3.4; 2.7.1; 10.2.3

characters see worded markings

chevrons **2.11**; Fig 2-16

distance apart 11.6.5

raised profile 2.6.5

- refuge 2.8.3
- separation 11.6; Fig 11-6
- studs 4.4.1; 4.5.2
- chicane 2.5.10; Table 2-7; 10.1.2; 10.5.1; **10.6**; see *also* traffic calming
- “Children” Table 11-4
- chord markings 11.3.2; Fig 11-2
- clear visibility distance see visibility distance
- compulsory turns 9.3
- conspicuity 1.6.2; 1.6.4; 5.3.12; 6.3.3–6.3.5
- crest see hills
- cross hatching see hatching; yellow box
- Cross-Sections and Headrooms (TD 27) 2.12.1; 7.1.1
- “Cycle hire” Table 11-4
- cycle lane 2.4.1; Table 2-3; 2.5.3; 2.5.5; Table 2-5; 2.7.3; 2.7.5; 2.11.1; 9.5.1; 10.2.5; Table 12-1
- cyclists 2.6.7; 2.6.8; 2.9.4; 6.10.6
 - risks to 2.6.2; 2.6.4; 6.8.3; 10.5.1; 10.7.2
- Department for Infrastructure (Northern Ireland) 1.1.3; 1.2.5; 1.4.3; App A; Table A-1
- Department for Transport 1.1.3
- Design Manual for Roads and Bridges (DMRB) 1.5.1; 2.12.1; 12.7.1
- Design of Mini-Roundabouts (TD 54) 6.1.5; 6.3.1; 6.3.2
- Design of Wide Single 2+1 Roads (TD 70) 2.2.2; 3.10.1
- Directions see Traffic Signs Regulations and General Directions 2016
- “Disabled” Table 11-4
- DMRB see Design Manual for Roads and Bridges
- “Doctor” Table 11-4
- double white lines **3.1**; Fig 3-1; App A
 - arrows 2.7.2; 3.4; Fig 3-2; Fig 3-3
 - centre 2.2.2; 3.9.1; 11.3.4; Fig 11-2
 - hatching 2.7.1
 - inclined 3.6
 - junction 3.7; 5.3.2
 - lanes 3.9.1; 3.10.1; 3.11; 3.14.1

- level crossing 3.15
- materials 3.2.2
- splayed 3.5
- studs 1.2.4; 3.3.1; 4.1.2; 4.1.5; 4.5.1
- taper 3.5.1
- visibility 2.4.5; 3.1.2; 3.1.5; 3.8
- yellow box 8.5.2
- drainage 2.6.10; 6.10.6; 10.5.1; Fig 11-6; 12.2.7; 12.8
- drawings 1.10
 - bilingual 1.10.2
 - dimensions 1.10.1
- dual carriageway
 - arrow 9.6.3; 9.6.4
 - bend 2.10.2
 - central reservation 2.5.12; 2.10.2; 2.10.4; 4.4.2; 9.6.4
 - edge 2.5.11; 2.5.12; 2.12.3
 - end 2.10; Table 2-6; 2.10.4; Fig 2-15
 - hatching 2.7.4; Fig 2-9
 - junctions 2.3.5; Table 2-5; 2.12.1; **5.4**; Fig 5-11; Table 7-1; Table 7-2
 - lane lines 2.3.5
 - lane loss Fig 2-9; 7.6.2
 - level crossing 8.5.1
 - roundabouts 6.3.1; 6.7.3
 - separation 2.11.2; Fig 2-16; 11.6.1
 - single lane dualling 5.5; Fig 5-12
 - studs 4.5.2
 - unlit 2.5.11
 - upright signs 11.6.6
 - warning lines 2.4.13
 - yellow bars 6.10.3
- edge of carriageway 1.2.5; 1.6.3; 1.7.1; **2.5**; Fig 2-6; Table 2-5; 2.5.10; Fig 2-18; Fig 2-19
 - bridges 11.3.3

- build-out 10.5.1; 10.5.3
 - gateways 10.7.2; 10.7.3
 - hatching 2.7.5; Fig 2-10
 - hard shoulder 2.7.6; Fig 2-11; 2.12.2
 - lane loss 2.7.4; Fig 2-9
 - placement Table 2-5; 2.5.8; 2.5.9; 2.5.13
 - raised profile 2.6; Fig 2-7; 2.12.2
 - reflectorised 12.4.2
 - slip road 7.2.3–7.2.4
 - studs Table 2-5; 2.5.12; 2.5.13; 2.12.3; 4.4.1; 4.5.1–4.5.3
 - thermoplastic hump 10.4.1
 - visibility 1.7.3; 2.2.6
- “Electric motorcycles, M/cycles, M/cs” Table 11-4
- “Electric vehicles/vehs” Table 11-4
- elongation *see* worded markings, elongation
- font *see* worded markings
- footways 2.5.6; 10.5.1
- four-lane road 3.14
- gateways 10.7
- Geometric Design of Major/Minor Priority Junctions (TD 42) 5.1.1; 5.3.6; 5.3.7; 5.3.10; 5.3.14; 5.4.1; 5.4.5
- Geometric Design of Roundabouts (TD 16) 6.1.4; 6.1.5; 6.2.1
- Geometric Layout of Signal-Controlled Junctions and Signalised Roundabouts (TD 50) 6.1.5; 6.5.1
- ghost island 7.2.6; **7.5**; Fig 7-2; 10.7.2
- arrows 5.3.8; Fig 9-5
 - crossroads 5.3.4; Fig 5-10
 - diverge 7.5.1–7.5.3; Fig 7-8; Fig 7-9; Table 7-3; 7.6.2
 - junctions 5.3; Fig 5-4; Fig 5-5; Fig 5-6
 - taper Table 7-1; 7.3.3; Fig 7-5; Fig 7-6
 - warning lines 7.3.2; Fig 7-4
- “Give way” line 2.3.3; 2.4.11; 2.5.2; 2.5.3; Table 2-5; 4.4.1; 12.7.5; App A
- absence of 12.7.5

- arrows 9.1.1; Table 9-1
- build-out 10.5.2
- priority system 11.3.5
- roundabouts 6.1.1–6.1.3; Fig 6-1; 6.2.2; 6.3.6; Fig 6-3; 6.3.8; 6.5.2; 6.10.5; 6.11.1–6.11.3; Fig 6-9
- “Slow” 11.2.1
- green studs see road studs, green
- gyratory 6.7.3; 8.1.1; Fig 8-3; 9.2.1
- hard shoulder Fig 2-18; Fig 2-19; 6.10.6; 11.6.6
 - actively managed 2.5.6; Table 2-5; 2.6.2; 2.6.3; 4.4.1; **7.7**
 - edge 2.5.6; Table 2-5; 2.5.10; 2.6.2
 - raised profile markings 2.6.9
 - road studs 2.12.3; 4.4.1
 - roads without 2.7.4; 2.11.2; 11.6.6
 - termination 2.6.5; 2.7.6; Fig 2-11
- hard strip 2.5.11; 2.6.8; 2.6.9; 5.3.3; 5.3.4; 5.5.1; Fig 2-18; see *also* hard shoulder
- hatching **2.7**; 10.7.2; App A; see *also* chevrons; yellow box
 - angle 8.2.2; 8.2.4
 - dimensions 2.7.1; Table 2-3
 - double white lines 3.5.1; Fig 3-4; 3.10.1; Fig 3-6; Fig 3-8; Fig 3-9; 5.3.12; 5.3.13
 - centre of carriageway 2.7.2; Fig 2-8; Fig 2-13; Fig 2-14; 3.10.1; Fig 3-6
 - edge of carriageway Table 2-6; 2.7.5; Fig 2-10; 5.3.2; 11.3.3
 - end of dual carriageway Table 2-6; 2.10; Fig 2-15
 - end of hard shoulder 2.7.6; Fig 2-11
 - ghost island 7.5.1; Fig 7-8; Fig 7-9
 - junction 5.2; 5.3; Fig 5-5; Fig 5-6; 7.2.7
 - island 2.7.1; Table 2-7; 2.8
 - narrowing 2.7.4; Fig 2-9; Fig 7-4
 - refuge 2.8; Table 2-7; Fig 2-12; Fig 2-13; Fig 2-14; 10.7.2
 - roundabout Fig 6-1; 6.2.2; 6.3.4; 6.3.7; Fig 6-7
 - separation 2.7.3; 2.8.1; Fig 2-8; 5.3.13; Fig 6-7
 - studs 3.3; 4.1.2; 4.1.5
 - tapers 2.7.2; Table 2-6; Table 2-7; 3.12.1; 10.7.3

- visibility 5.3.12
- hazard markers *see* warning lines
- HGVs Table 2-1; Table 2-2; Table 2-3
- high vehicles 9.2.2; 11.3; Fig 11-2
- Highway Link Design (TD 9) 2.12.1; 3.11.2; 3.12.1; 6.10.3
- hills 3.11; 3.12; *see also* sag curve
- humps *see* road humps
- illumination 2.6.1; *see also* retroreflectivity
- inclined markings 2.8.1; 2.9.2; 3.6; Fig 3-5; 9.6.5
- informatory signs 7.5.2; Fig 7-8; Fig 7-9; *see also* advance direction signs
- Inspection and Maintenance of Road Markings and Road Studs on Motorways and All-purpose Trunk Roads (TD 26) 12.7.1
- junctions Fig 2-5; 3.7; **5.1**
 - auxiliary lanes 7.6
 - dual carriageway 5.4; Fig 5-11
 - ghost island 5.3; Fig 5-4; Fig 5-5; Fig 5-6; 7.5
 - grade-separated 7.1
 - hard shoulder 7.7
 - lane drop 7.4
 - lane gain 7.3
 - markings between 2.12
 - signal-controlled Fig 9-4
 - single-lane 5.5
 - T-junctions Fig 5-1; Fig 5-2
 - tapers 7.2
 - warning lines Table 5-1
 - yellow box 8; Fig 8-1; Fig 8-2; Fig 8-3; Fig 8-6
- “Keep clear” 6.9.2; 8.3.3; 8.3.5; 11.4; 11.4.4; 11.4.5; Table 11-3; Table 11-4
- lane markings *see* road markings, lane
- large vehicles 2.9.4; 3.11.6; 6.3.1; 6.8.6; 10.7.2
- “Large vehicles/vehs” Table 11-4
- Layout of Grade Separated Junctions (TD 22) 7.1.1; 7.2.6; Table 7-4; 7.5.1; Fig 7-8; Fig 7-9; 7.6.1; 7.6.2

- left-hand bend 1.7.3; 3.9.1
- left-hand lane 3.11.1; 6.8.2; 7.3.3
- legal interpretations 1.1.1; 1.2.3
- legend *see* worded markings
- lettering *see* worded markings
- level crossing 2.5.6; 3.1.8; 3.3.1; **3.15**; **8.5**; 10.5.2; 12.7.5
- lighting 4.1.1; 4.1.3; 12.7.5 *see also* reflectorisation
- loading 3.1.1; 8.3.4; 8.3.5; 11.4.7; 12.5.3
- “Loading” 11.7.7; Table 11-4
- loading bay 11.4.7
- Local Transport Note 1/09 Signal Controlled Roundabouts 6.5.1
- long vehicles 5.3.7; 11.3.2; Fig 11-2
- longitudinal lines 2.1; *see also* chevrons; hatching
 - centre 2.2
 - double white 3.1
 - edge 2.5; 2.6
 - hatched 2.7
 - lane 2.3
 - warning 2.4
- maintenance 1.6.2; 2.2.6; 6.3.3; 6.10.7; **12.7**
- mandatory requirements *see* Traffic Signs Regulations and General Directions 2016
- materials 12.1; **12.2**; *see also* reflectorisation
 - application 12.6; Table 12-2
 - colours 12.5
 - standards 12.3
 - temporary markings 12.2.1; 12.3.4; 12.7.4
- ‘may’ 1.3.1
- mini-roundabouts Fig 6-2; Fig 6-3; Fig 6-4; Fig 6-5; 6.3.9; *see also* roundabouts
 - Mini-roundabouts: Good Practice Guidance* 6.3.9
- motorcyclists 2.6.9; Table 11-4
- motorways Fig 2-19
 - actively managed 7.7

- arrows 9.6.3
 - chevrons 11.6.1; Fig 11-6; 11.6.6
 - convergence 2.11.2
 - edge of carriageway 2.5.6; Table 2-5; 2.5.11; Fig 2-19; 2.6.2; 2.6.3; 2.12.2
 - hard shoulder 2.7.6; Fig 2-11
 - lane lines 2.3.5
 - lane loss 2.7.4; Fig 2-9
 - materials 12.3.2
 - refuge 2.5.4
 - slip road 2.11.2; Fig 2-17; 7.2.3
 - smart 2.5.4; 2.5.6; 2.6.3; 4.4.1
 - studs 4.1.3; 4.4.1
 - tapers Table 7-1; Table 7-2; 7.2.6; Fig 7-8; Table 7-5
 - yellow bars 6.10.3
- 'must' 1.3.1
- national authority 1.1.3
 - powers 1.2.6; 1.2.7; 1.3.2; 4.1.1
- nearside lane 3.11.1; 3.11.5; 3.11.6; 3.11.7; 6.1.2; 6.2.3; 7.2.3; 7.2.4; 9.1.3
- New Roads and Street Works Act 1991 1.2.1
- "No overtaking" 3.1.2; 3.1.4
- Northern Ireland Regulations see Traffic Signs Regulations (Northern Ireland) 1997
- obstructions 2.7.3; 2.9.4; 8.3.3; 8.3.5; 9.5.1
- off-side lance 2.5.11; 2.7.5
- oncoming vehicles 1.7.4; 1.7.5; 4.5.3; 8.1.2; 8.1.3
- "Only" Table 11-4
- overtaking 2.4.5; 2.4.12; 2.9.2; 2.9.4; 3.1.1; 3.1.2; 3.6.1; 3.7.1; 3.8.1; 3.9.1
- parallel boundary 2.7.3; Fig 2-13; Fig 2-14; 3.6.1; 7.6.1; 7.6.3
- parking 1.1.4; 2.2.5; 10.5.1; 10.5.3; 11.4.7; 12.2.7; 12.4.2; 12.5.5
- pedestrians 2.8.3; 6.8.5; 10.2.1; 10.6.4; 11.4.5; 11.5.1
 - crossings 1.1.4; 6.11.3; 11.5.1
 - hazards 2.6.4; 2.6.7; 6.8.5; 8.3.1; 10.3.3; 10.5.3; 10.6.1; 10.6.4
 - refuge 2.8.3; 2.9.1; 2.11.1; 11.5.1–11.5.2

“Permit holders” Table 11-4

“Police” Table 11-4

private access 2.5.3–2.5.4; Table 2-5; 3.7.2; 5.3.2; 11.4.2; 11.4.4; 11.4.7

public access 1.2.1

queues 8.3.1; 8.3.2; 8.3.3; 8.3.6; 8.3.7; 9.1.1; 11.4.2

railway crossing see level crossing

raised profile markings 1.9.2; **2.6**; Fig 2-7

red routes 1.8.1

refuge 2.4.1; 2.4.8; 2.7.2; 2.7.3; Table 2-5; Table 2-6; 2.8.2; Table 2-7; Fig 2-12; 3.4.4; 3.6; Fig 3-5; 10.7.2; 12.7.6

 emergency 2.5.4; Table 2-5; 2.6.3; 4.4.1

 pedestrian 2.6.7; 2.8.3; 2.9.1–2.9.2; 2.11.1; 11.5.1; Fig 11-5; 11.5.2

reflectorisation **1.9**; **12.4**; Table 12-1

 studs 2.5.4; 2.12.3; 3.3.2; 4.1.5; 4.3.1; 4.4; 4.4.2

 lines 3.2.2; 4.1.1

Regulations see Traffic Signs Regulations and General Directions 2016

retroreflection 1.7.4; 1.7.5; 1.9.1; 2.6.1; 2.12.3; 4.1.1; 4.2.1; 4.3.2; 4.4.1; 4.4.3; 6.3.5; 12.3.1; 12.3.2; 12.4.1; 12.4.3; 12.7.2

right-hand bend 1.7.3; 2.10.2

right-hand lane Fig 2-9; 6.7.2; 7.3.3; Fig 7-2; Fig 7-5

right of passage see public access

road hump 2.4.1; 10.1.3; **10.2**; Fig 10-1; Fig 10-2; Fig 10-3; Fig 10-4; **10.4**; 12.4.2; App A;
 see *also* speed cushion

road markings 1.1.4; 1.6; see *also* boundary; worded markings

 angle 1.6.4

 colours **1.8**; 5.3.2; 5.3.14; Fig 5-7; 10.4.1; 11.4.3; 12.5

 lane 1.6.3

 splayed 3.5

road studs 2.5.4; 2.5.13; 2.8.2; 2.10; 3.2.2; 3.3; **4.1**; Table 5-1; Fig 7-1; 12.3.3; 12.7.4–12.7.6

 amber 2.5.12; 2.7.4; Fig 2-9; 2.10.4; 2.12.3; 4.4.1; 4.4.2; 4.5.2; Fig 7-1; 7.2.3; 7.2.7; Fig 9-7

 green 2.5.4; 4.1.1; 4.4.1; 4.4.4; Fig 5-11; Fig 7-1; 7.2.4; 7.4.1; 7.5.3; 7.5.4; Fig 9-7

 red 2.5.12; 2.7.4; Fig 2-9; 2.10.4; 2.11.3; 2.12.3; 4.4.1; 4.4.2; 4.5.2; 6.8.6; Fig 7-1; 7.2.2; 7.2.3; 7.2.4; 7.2.6; 7.3.4; 7.5.4

- spacing 2.5.13; Table 2-1; Table 2-2; Table 2-3; Table 2-5; **4.5**; 7.2.4; 7.4.1; 7.5.3; 7.5.4
- temporary 4.4.4
- types 4.3
- white 1.2.4; 2.7.3; Fig 2-9; 2.10.3; 2.10.4; 3.3.1; 4.1.2; 4.4.1; 4.4.3; Fig 7-1
- Road Traffic Act 1988 1.2.3; 3.1.7; 8.1.5; App A
- Road Traffic Regulation Act 1984 1.1.2; 1.2.1; 1.3.2
- Roads (Scotland) Act 1984 1.1.2
- roundabouts 6.1; 6.2; *see also* mini-roundabouts
 - arrows 6.7
 - destinations 6.7
 - double 6.4
 - lanes 6.6
 - left turns 6.8
 - signalised 6.5
 - yellow bars 6.10
 - yellow box 6.9
- rural roads 2.2.2; 2.2.6; 2.5.7; Fig 2-18; Fig 2-19; 3.10.1; 5.3.2; 5.3.4; Table 7-1; Table 7-2; 7.2.6; Table 7-5; 10.7.1
- safety 1.6.3
 - edge of carriageway 2.5.7
 - ghost island 5.3.2
 - lane 1.6.3; 2.3.1; 3.11.4
 - materials 12.2.7
 - mini-roundabouts 6.3.1
 - refuge 10.7.2
 - yellow bars 6.10.4
- sag curve 3.13
- “School keep clear” Table 11-4
- Secretary of State for Transport *see* national authority
- Segregated Left Turn Lanes and Subsidiary Deflection Islands at Roundabouts (TD 51) 6.8.2; 6.8.4
- ‘should’ 1.3.1
- sight line 3.11.3; 6.9.2

- single carriageway 2.2.1–2.2.2; Table 2-1; 2.3.4; 2.4.6; 2.4.13; Table 2-3; 2.5.10; 2.9.1; 3.10.1; 3.14.1
- skid resistance 6.10.7; 12.3.1; 12.3.2; 12.6.2
- slip road 7.2; 7.5
- entry 7.2.1; 7.2.6; Fig 7-2; 7.3.1–7.3.3; Fig 7-3
 - exit 6.10.1; 6.10.3; 7.2.1; 7.2.2
 - lane gain 7.3.1–7.3.3; Fig 7-2; Fig 7-4; Fig 7-5; Fig 7-6; 7.4.2
 - lane loss 2.7.4; 7.2.7; Fig 7-3; Fig 7-4; 7.3.3; Fig 7-5
 - raised profile edge 2.6.2; 2.6.5
 - roundabout 6.7.3
 - separation 2.11.2; 11.6.5
 - studs 4.4.1
 - taper 7.2.1; 7.2.2–7.2.4; Fig 7-1; 7.2.7; Fig 7-3; Table 7-4; 7.4.2
 - two-lane 7.2.6; Fig 7-2
 - yellow bars 6.10.1; 6.10.3; 6.10.5; Table 6-2
- “Slow” 11.1.2; 11.2; 11.7.5
- “Slow vehicles, vehs” Table 11-4
- slow vehicles 2.9.4; 3.11.1; 7.3.3
- smart motorway *see* motorways, smart
- “Solo motorcycles, M/cycles, M/cs” Table 11-4
- Specification for Highway Works 12.3.2
- speed cushion 10.1.3; 10.3; Fig 10-5; App A; *see also* road hump
- speed limit 2.1.2; 2.2.1; 2.2.3; 2.2.4; Fig 2-2; 2.3.5; 2.4.5; 2.4.9; 2.4.11; 2.4.13; 2.7.1; 2.8.2; 5.3.5; 5.3.8; 5.4.1; 5.4.3; 5.5.1; 6.3.2; 6.10.3; 7.3.2; 9.2.3; 9.6.3; 10.7.2; 11.2.1; 11.4.6; 11.6.1; Table 11-3
- “Stop” 2.3.3; 2.4.11; 2.5.3; Table 2-5; 4.4.1; 9.1.1; Table 9-1; 11.2.2; Table 11-3; 12.7.5
- roundabout 6.6.2; 6.6.7
 - traffic signal 6.5.2; 8.4.1
- stopping restriction 3.1.1; 3.1.8; 3.14.1
- “Taxi” Table 11-4
- TD 9 *see* Highway Link Design
- TD 16 *see* Geometric Design of Roundabouts
- TD 22 *see* Layout of Grade Separated Junctions

- TD 26 see Inspection and Maintenance of Road Markings and Road Studs on Motorways and All-purpose Trunk Roads
- TD 27 see Cross-Sections and Headrooms
- TD 42 see Geometric Design of Major/Minor Priority Junctions
- TD 50 see Geometric Layout of Signal-Controlled Junctions and Signalised Roundabouts
- TD 51 see Segregated Left Turn Lanes and Subsidiary Deflection Islands at Roundabouts
- TD 54 see Design of Mini-Roundabouts
- TD 70 see Design of Wide Single 2+1 Roads
- temporary markings 6.7.1; 12.2.1; 12.3.4; 12.7.4–12.7.5
- thermoplastic hump see road hump
- three-lane roads Fig 2-18; Fig 2-19; 3.10; 11.6.6
- thump see road hump
- tiger tail see ghost island
- traffic calming 10.1
- build-outs 10.5
 - chicanes 10.6
 - cushions 10.3
 - gateways 10.7
 - humps 10.2
 - pinch points 10.6
 - thermoplastic humps 10.4
- Traffic Management Act 2004 1.1.2
- Traffic Regulation Order 1.2.2; 1.2.3; 3.1.1; 8.1.5; 10.5.3; 10.7.1; 11.4.7
- traffic signs 1.6.1; 2.2.3; 2.4.11; 2.4.12; 2.5.10; 2.10.1; 3.10.1; 3.11.7; 6.3.6; 6.3.8; 6.11.2; 6.11.3; 7.5.1; 7.5.2; Fig 7-8; Fig 7-9; 9.1.3; 9.2.2; 9.2.4; 10.2.5; 10.5.2; 11.6.6; 11.7.7; 12.7.5
- Traffic Signs Regulations and General Directions 2016 (TSRGD) 1.1.1; 1.4.1; App A
- compliance with 1.1.2; 1.4.2; 1.4.3; 6.9.2
 - modification 1.2.6
- Traffic Signs Regulations (Northern Ireland) 1997 1.4.2–1.4.3; App A
- tramway markings 1.1.4; 2.5.5; Table 2-5; 8.3.8; Fig 8-5; 9.5.1; Table 11-3
- triangle 6.11.2; 10.2.2; 11.2.2
- TRO see Traffic Regulation Order
- trunk roads 12.3.2

TSRGD see Traffic Signs Regulations and General Directions 2016

two-lane roads 2.11.2; Fig 2-18; Fig 2-19; Fig 3-2; 3.9.1; 7.2.6; Fig 7-2; Fig 7-4; 7.4.2

typeface see worded markings

UK Roads Liaison Group 12.7.1

unlit roads 1.6.3; 1.7.2; 2.5.6; 2.5.11

visibility 1.7; 2.2.3; 2.4.5; 3.1.2; 3.1.4–3.1.5; 12.4.3; see *also* visibility distance

hatching 8.2.4

level crossing 3.15.1

lines 2.2.3; 2.3.5; 2.4.5; 3.7.1

junction 5.3.8; 5.3.12

roundabouts 6.1.2

studs 4.1.1

visibility distance 2.4.5; Table 2-4; 3.6.1; **3.8**; Table 3-2

definition 3.8.1

factors affecting 1.7.3–1.7.5; 3.9.1; 3.11.3

lines 2.3.5; 3.6.1; Table 3-2

three-lane hill 3.11.1; 3.11.3–3.11.6

two-lane road 3.9.1

warning line 2.4.5; Table 2-4; 3.8.1; Table 3-2

warning line 2.2.4; Fig 2-2; **2.4**; Fig 2-4; Table 2-3

alternative 2.7.3

arrows 5.3.9; 5.4.3; Table 9-1

authority 3.1.7

change to 2.2.2; 2.2.3; 2.3.3; 2.4.1; 2.4.5; 2.4.13; 2.4.14; 2.9.3; 2.10.3; 3.1.4; 3.11.5;
7.2.5; 7.5.4; 7.6.2; 11.3.2; 11.3.4

inclined 2.8.1

junction 2.4.8–2.4.10; 2.9.3; Table 5-1; 5.3.2; 5.3.3; 5.3.12; 5.4.2

lane gain 7.3.2

road hump 10.2.3

roundabouts 6.1.2–6.1.3; 6.2.2; 6.3.4

separation 2.4.6; 2.4.7; 5.3.3; 9.2.3

studs Table 2-1; Table 2-2; Table 2-3; 4.5.1

taper 2.8.2

visibility 2.2.3; 2.4.3; 2.4.5; Table 2-4; 3.1.2; 3.8.1; Table 3-2; 3.9.1–3.9.2; 3.11.3

yellow box 8.5.2

Well-managed Highway Infrastructure: A Code of Practice 12.7.1

white studs *see* road studs, white

worded markings 1.6.4; **11.1**; 11.7

destinations 9.2.1–9.2.2

elongation 1.6.4; 11.5.3; 11.7.1–11.7.2; Table 11-2; Table 11-3; 11.7.4–11.7.6; 11.7.7;
Table 11-4; Fig 11-9

lettering 11.7; Table 11-2; Table 11-3; Table 11-4; Fig 11-9

“High vehs” 11.3; Table 11-1

“Keep clear” 11.4; Fig 11-3; 11.4.5

“Look left/right” 11.5; Fig 11-5

“No entry” 11.1.2

“Play street” 11.1.2

“Slow” 11.2

working drawings *see* drawings

x-height Fig 11-9

yellow box 8.3; Fig 8-1; Fig 8-2; *see also* junctions

design 8.2; 8.4

legal 8.1

level crossings 8.5

half box 8.3.2; Fig 8-2; 8.3.5

narrowing 8.3.7; Fig 8-4; 8.4.1

roundabout 8.3.6; Fig 8-3; 8.4.1

setting out 8.4; Fig 8-6

staggered junction 8.3.5

traffic flow 8.3.1; 8.3.4; 8.3.5; 8.3.7

tramway 8.3.8; Fig 8-5